



RT100

EN13000

LIFTING CAPACITY CHART - TABELLE DI CARICO TABLEAUX DES CHARGES - TRAGKRAFT TABELLE LASTTABEL - TABLAS DE CARGA

s/n:

These load tables are an integral part of the Manual Using the machine and must always accompany it.

Le presenti tabelle di carico costituiscono parte integrante del Manuale di Uso della macchina e devono sempre accompagnarlo.

Ces tableaux de charges sont une partie intégrante du Manuel d'utilisation de la machine et doit toujours l'accompagner.

Diese Belastungstabellen sind ein integraler Bestandteil des Handbuchs Verwendung des Gerätes und muss immer begleiten.

Deze belasting tafels zijn een integraal onderdeel van de gebruikershandleiding van het apparaat en moet altijd te vergezellen.

Estas tablas de carga son una parte integral del Manual de Uso de la máquina y siempre debe acompañarlo.

DEFINITIONS

RATED LIFTING CAPACITY :

The total suspended load, including the weight of handling accessories, that the machine can safely lift under ideal conditions at a given boom length, boom radius and boom angle for a given outrigger and slewing configuration.

LOAD RADIUS :

The horizontal distance measured between the center of rotation and the boom point sheave axis.

LOADED BOOM ANGLE :

The angle between the longitudinal centre line of the boom base section and the horizontal after lifting the rated load at the rated load radius.

BOOM POINT ELEVATION :

The vertical distance measured between the ground and the boom point sheave axis.

FREELY SUSPENDED LOAD :

Lifted load hanging free with no direct external force applied except by the hoist line.

WORK AREAS :

Area measured in a circular arc about the centre line of rotation as shown in the area of operation diagram.

FULLY EXTENDED OUTRIGGERS :

All outrigger beams are fully extended and the machine is raised on all four outriggers with the wheels completely clear of the ground.

INTERMEDIATELY EXTENDED OUTRIGGERS :

All outrigger beams are extended to the intermediate position and the machine is raised on all four outriggers with the wheels completely clear of the ground.

FULLY RETRACTED OUTRIGGERS :

All outrigger beams are fully retracted and the machine is raised on all four outriggers with the wheels completely clear of the ground.

WARNING

For a safe use of the crane follow the instructions of the operating manual.

- Cranes lifting capacities shown are for this machine as originally manufactured and delivered. The lifting capacities only apply when all the instructions in this book are rigidly followed. Modifications to this machine or the use of equipment other than that specified is not authorized.
- Reduced crane lifting capacities for the particular job shall be established by the user with due allowance for adverse operating conditions, These conditions include the supporting surface, pendulum action of the load, jerking or sudden stops of load and other factors affecting stability, two machine lifts, electrical wires, adverse weather, wind, hazardous surroundings, experience of personnel, etc...
- Crane lifting capacities are based on freely suspended loads with the machine levelled and standing on a firm uniform supporting surface, Depending on bearing surface nature, steel section supports may be required under the outriggers for even load distribution so that limit bearing values are not exceeded, No attempt shall be made to move a load horizontally on the ground in any direction.
- Side loading of the machine and load swing out may cause structural failure or machine tip-over, Side loads may be generated by: lifting when not level; swinging when not level; dragging a load; sudden accelerating or deceleration in swinging; wind forces on load and boom structure; pushing a load.
- Loaded boom angles at specified boom lengths give only an approximation of operating radius, The boom angle before loading should be greater to account for boom deflection as the load is lifted from the ground.
- Rated lifting capacities are based on correct revving, Deduction must be made for excessive revving, Any revving over minimum required (see wire rope strength table) is considered excessive and must be accounted for.
- Positioning or operation at radii or boom lengths beyond the maximum or minimum shown, is neither intended nor approved.
- When one, or both of the radius and boom Length parameters is found to be between the values indicated on the capacity chart, then use the following procedure: respect the lowest load capacity corresponding to either; the immediately higher or immediately lower radius parameter indicated on the chart; or, the immediately higher or immediately lower boom length parameter indicated on the chart.
- Positioning or operation of extensions or jibs at boom angles beyond the maximums or minimums shown, is neither intended nor approved.
- It is safe to attempt to telescope any load within the limits of the load rating chart.

NOTES

1 CAPACITY

The calculations underlying these diagrams were made in accordance with standard EN13000. Given values are valid for the operating conditions specified in categories S0-HC1. Given load capacities are maximum load covered by manufacturer's warranty when machine is used under the conditions and within the limits specified in the operating and maintenance instructions. Load capacities are expressed in metric tons. The weight of hook blocks and other handling equipment must be subtracted from given load capacities as specified below.

2 LOAD RATING REDUCTION

When lifting a load with main boom and extension – whether side-mounted through brackets or mounted on boom nose – subtract the weights indicated below from the load rating listed in the relevant chart.

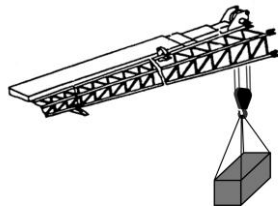

8-metre extension	600 kg
15-metre extension	800 kg

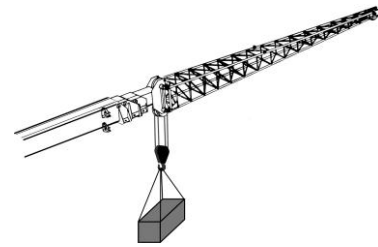

8-metre extension	900 kg
15-metre extension	1650 kg

3 EXTENSIONS

When using any extensions or the mechanical pull-out boom section, if boom is not fully extended crane load capacity is determined based on boom angle and not working radius.

4 ADDITIONAL PULLEY ON BOOM HEAD

Maximum lifting capacity is limited to 3800 daN when the additional pulley on boom head is used, regardless of machine configuration.

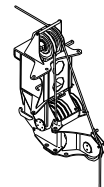

5 CAPACITIES WHEN LIFTING ON TYRES

In the load configuration for lifting on tyres, superstructure rotation is only allowed when telescoping boom angle is 70° the limits.

**PORTATA DI ESERCIZIO :**

Rappresenta il carico totale sospeso, compreso il peso degli accessori di movimentazione, che la macchina può sollevare in condizioni di sicurezza ideali per assegnati lunghezza, raggio ed angolo del braccio in una data configurazione degli stabilizzatori e della rotazione.

RAGGIO DI CARICO :

Rappresenta la distanza orizzontale misurata dal centro di rotazione della sovrastruttura alla verticale abbassata dall'asse delle pulegge sulla testa del braccio.

ANGOLO DEL BRACCIO SOTTO CARICO :

Rappresenta l'angolo determinato dall'asse centrale longitudinale della sezione base del braccio e dall'asse orizzontale, ottenuto dopo avere sollevato il carico nominale rispettando il raggio nominale di carico.

ELEVAZIONE PUNTA DEL BRACCIO :

Rappresenta la distanza misurata verticalmente dal terreno all'asse delle pulegge sulla testa del braccio.

CARICO LIBERAMENTE SOSPESO :

Rappresenta il carico sollevato in libera sospensione, senza nessuna forza esterna applicata direttamente tranne quella della fune di sollevamento.

ZONE DI LAVORO :

Rappresenta l'area compresa all'interno di un arco circolare rispetto all'asse centrale di rotazione della sovrastruttura come riportato nel diagramma della zona operativa.

STABILIZZATORI IN POSIZIONE DI MASSIMA ESTENSIONE :

Le travi porta-stabilizzatori sono completamente estese e la macchina viene sollevata su tutti e quattro gli stabilizzatori con le ruote completamente staccate dal suolo.

STABILIZZATORI IN ESTENSIONE INTERMEDIA:

Le travi porta-stabilizzatori sono estese nella posizione intermedia e la macchina viene sollevata su tutti e quattro gli stabilizzatori con le ruote completamente staccate dal suolo.

STABILIZZATORI COMPLETAMENTE RETRATTI:

Le travi porta-stabilizzatori sono completamente rientrate e la macchina viene sollevata su tutti e quattro gli stabilizzatori con le ruote completamente staccate dal suolo.

AVVERTENZE

Per un corretto uso dell'autogrù fare sempre riferimento al Manuale di Uso.

- Le portate indicate della gru si riferiscono alla presente macchina così come fabbricata e fornita in origine. Tali portate sono applicabili solo qualora vengano rigorosamente rispettate le istruzioni riportate nel presente documento e nel Manuale di Uso. Qualsiasi modifica alla macchina od impiego di attrezzature diverse da quelle specificate non è autorizzato.
- L'utilizzatore, in base al tipo di lavoro da svolgere ed in presenza di condizioni di funzionamento avverse, dovrà di volta in volta considerare una possibile riduzione della portata delle gru. Tali condizioni comprendono fattori quali la superficie di appoggio, le oscillazioni del carico, gli arresti improvvisi dei movimenti del carico ed gli altri fattori che influiscono sulla stabilità, la presenza di linee dell'alimentazione elettrica, il maltempo, il vento, l'ambiente circostante pericoloso, l'esperienza del personale, ecc.
- Le portate della gru si riferiscono a carichi liberamente sospesi con la macchina livellata e ubicata su una superficie di appoggio solida, stabile ed uniforme. A seconda della natura della superficie di appoggio, potrebbe essere necessario posizionare dei supporti in profilato d'acciaio sotto lo stabilizzatore per distribuire il carico in modo tale da evitare che vengano superati i valori limite della capacità di sostegno della superficie stessa. Evitare di trascinare orizzontalmente sul terreno in qualsiasi direzione i carichi.
- Il caricamento laterale della macchina e l'oscillazione del carico possono provocare cedimenti o ribaltamenti della macchina. Tale caricamento laterale può essere causato da un sollevamento non a livello, oscillazioni non a livello, trascinamento di un carico, improvvisa accelerazione o decelerazione dell'oscillazione, forza del vento sul carico e sulla struttura del braccio, spinta del carico.
- Gli angoli del braccio sotto carico a lunghezze di braccio determinate danno solo un'approssimazione del raggio operativo. L'angolo del braccio, prima dell'applicazione del carico, potrà essere maggiore data la flessione del braccio durante il sollevamento del carico dal suolo.
- Le portate di esercizio si riferiscono ad un corretto sistema di taglie della fune. E' necessario ridurre il numero di taglie in eccesso. Taglie superiori a quanto richiesto (vedi tabella resistenza funi) sono da considerarsi in eccesso e devono essere calcolate.
- Il posizionamento o il funzionamento a lunghezze di raggio o di braccio superiori al massimo o al minimo indicati non sono previsti né approvati.
- Qualora uno od entrambi i parametri di raggio o lunghezza del braccio rientrassero fra quelli indicati sul diagramma di portata, rispettare la portata più bassa corrispondente al raggio e alla lunghezza del braccio; riferirsi al parametro di raggio immediatamente superiore od inferiore indicato sul diagramma, o al parametro di lunghezza del braccio immediatamente superiore od inferiore indicato sul diagramma.
- Il posizionamento od il funzionamento delle prolunghe o dei bracci con angoli di braccio superiori ai valori massimi e minimi indicati non sono previsti né approvati.
- Il sollevamento di carichi che rientrino nei valori limite del diagramma di carico di esercizio non comporta alcun pericolo.

NOTE

1 PORTATA

I calcoli riguardanti i presenti diagrammi si basano sulla norma EN 13000. I valori indicati sono validi per le macchine utilizzate alle condizioni previste dalle categorie S0-HC1. I carichi indicati sono quelli massimi coperti dalla garanzia di fabbricazione quando la macchina è utilizzata nelle condizioni e secondo i limiti previsti nel relativo manuale uso e manutenzione. Le portate sono espresse in tonnellate e il peso dei bozzelli ed altri accessori per la movimentazione deve essere sottratto dai carichi indicati così come sotto specificato.

2 RIDUZIONE DEI CARICHI DI ESERCIZIO

In caso di sollevamento con braccio principale e prolunga staffata a lato o montata sulla testa del braccio stesso, dedurre i valori sotto indicati dal carico indicato in tabella.

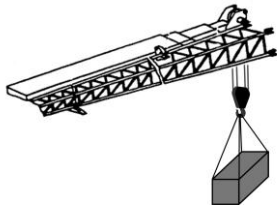

Prolunga 8 metri	600 kg
Prolunga 15 metri	800 kg

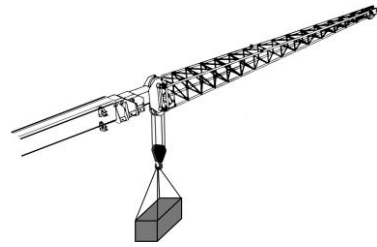

Prolunga 8 metri	900 kg
Prolunga 15 metri	1650 kg

3 PROLUNGHE

Per determinare la capacità di carico della gru quando si utilizzano le prolunghe o la sezione a sfilo meccanico del braccio e il braccio non è completamente esteso occorre fare riferimento all'angolo di sollevamento del braccio e non al raggio di lavoro.

4 PULEGGIA SUPPLEMENTARE SU TESTA BRACCIO

Per ogni configurazione della macchina, quando viene usata la puleggia supplementare su testa braccio, la capacità massima di sollevamento è comunque limitata a 3800 daN

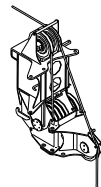

5 PORTATE SU PNEUMATICI

Nella configurazione di carico su pneumatici la rotazione della sovrastruttura è ammissibile solo limitando l'angolo di sollevamento del braccio telescopico a 70°

DEFINITIONS

CAPACITE DE LEVAGE :

Poids total de la charge suspendue avec les équipements de manutention que la grue peut lever dans des conditions optimales de sécurité pour une longueur, un rayon et un angle de la flèche dans une configuration donnée des stabilisateurs et de la rotation.

RAYON DE CHARGE :

Distance horizontale mesurée entre le centre de rotation de la structure du dessus et la verticale abaissée de l'axe des poulies sur la tête de la flèche.

ANGLE DE LA FLECHE SOUS CHARGE :

Angle déterminé par l'axe central longitudinal de la section de base de la flèche et par l'axe horizontal obtenu après levage d'une charge nominale en respectant le rayon nominal de charge.

HAUTEUR DE FLECHE :

Distance verticale entre le sol et l'axe des poulies sur la tête de la flèche.

CHARGE SUSPENDUE SANS CONTRAINTES :

Charge suspendue librement sans contrainte externe appliquée directement si ce n'est celle du câble de levage.

ZONES DE TRAVAIL :

Zone comprise à l'intérieur d'un arc circulaire par rapport à l'axe central de rotation de la structure du dessus, comme indiqué sur le schéma de la zone d'intervention.

STABILISATEURS EN EXTENSION TOTALE :

Toutes les poutres des stabilisateurs sont en extension totale et la machine est levée sur les quatre stabilisateurs avec les roues entièrement décollées du sol.

STABILISATEURS EN EXTENSION INTERMEDIAIRE :

Toutes les poutres des stabilisateurs sont en position d'extension intermédiaire et la machine est levée sur les quatre stabilisateurs avec les roues entièrement décollées du sol.

STABILISATEURS EN POSITION RENTREE :

Toutes les poutres des stabilisateurs sont en position rentrée et la machine est levée sur les quatre stabilisateurs avec les roues entièrement décollées du sol.

ATTENTION

Pour une utilisation correcte de la grue toujours consulter le manuel d'utilisation.

- Les capacités de levage de la grue ne s'appliquent que dans son état de fabrication et de montage d'origine. Les capacités de levage ne s'appliquent que si les instructions contenues dans ce manuel sont rigoureusement respectées. Toutes modifications faites sur cette machine ou utilisation des équipements autre que ceux spécifiés ne sont pas autorisées.
- Selon le type de travail à effectuer et en cas d'utilisation dans des conditions défavorables, l'opérateur doit éventuellement réduire la capacité de levage. Ces conditions comprennent des facteurs tels que l'état du sol, les oscillations de la charge, les arrêts soudains de la charge ainsi que d'autres facteurs susceptibles d'influencer la stabilité: la présence de lignes d'alimentation électrique, le mauvais temps, le vent, un environnement dangereux, l'expérience du personnel, etc.
- Les capacités de levage sont basées sur des charges suspendues sans contraintes, avec la machine mise à l'horizontale sur une surface d'appui solide, stable et uniforme. En fonction de la nature du sol, il est parfois nécessaire de rajouter des supports en profil d'acier sous le stabilisateur de façon à répartir la charge afin que la capacité de résistance du sol ne soit pas dépassée. Eviter de déplacer une charge horizontalement sur le sol quel que soit le sens.
- L'effort latéral et le balancement de la charge peuvent provoquer la rupture ou le renversement de la machine. Les efforts latéraux peuvent être générés par : le levage quand la machine n'est pas de niveau, le traînage de charge, les accélérations et freinage brusques pendant l'orientation, la force du vent sur la charge et sur la structure de la flèche, une poussée de la charge.
- Les angles de la flèche sous charge pour une longueur de flèche donnée ne donnent qu'une estimation approximative du rayon travail. L'angle de la flèche avant sa mise sous charge pourra être supérieur afin de compenser la flexion de la flèche quand la charge est levée du sol
- Les capacités de levage mentionnées dans ce document se réfèrent à un système correct de brins du câble. Il est nécessaire de réduire le nombre de brin en excès. Un nombre de brins supérieur au nombre nécessaire (voir tableau résistance câbles) doit être considéré en excès et doit être recalculé.
- Le positionnement ou le fonctionnement à des longueurs de rayon ou de flèche supérieurs au maximum ou au minimum indiqué n'est ni prévu ni autorisé.
- Quand un ou les deux paramètres : rayon et longueur de flèche se trouvent dans les valeurs indiquées sur le tableau, respecter la capacité de charge la plus basse correspondant au rayon et à la longueur de la flèche ; se référer au paramètre de rayon immédiatement supérieur ou inférieur indiqué sur le diagramme ou au paramètre de longueur du bras immédiatement supérieur ou inférieur indiqué sur le diagramme.
- Le positionnement ou le fonctionnement des rallonges ou des flèches avec des angles de flèches supérieures aux valeurs maximums et minimums indiquées n'est ni prévu ni autorisé.
- Le levage de charge rentrant dans les valeurs limite du diagramme des capacités de charge ne comporte aucun danger.

NOTES

1 CAPACITE DE CHARGE

Les calculs inhérents à ces diagrammes se fondent sur la norme EN13000. Les valeurs indiquées sont valables pour les machines utilisées aux conditions prévues par les catégories S0-HC1. Les charges indiquées représentent le maximum pouvant être couvert par la garantie de fabrication pourvu que la machine soit utilisée aux conditions et respectant les limites prévues dans le manuel d'utilisation et d'entretien. Les capacités de charge sont exprimées en tonnes et la masse des moufles et des autres accessoires de manutention doit être soustraite des charges ainsi qu'il est précisé ci-dessous.

2 REDUCTION DES CHARGES D'EXERCICE

En cas de levage via la flèche principale, allonge repliée et fixée de côté ou montée en tête de la flèche elle-même, déduire de la charge indiquée au tableau les valeurs ci-dessous.

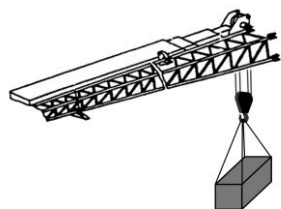

Allonge 8 mètres	600 kg
Allonge 15 mètres	800 kg

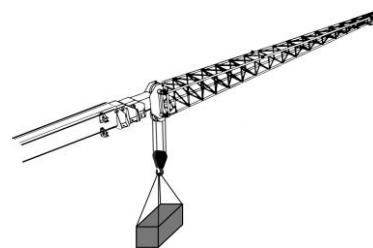

Allonge 8 mètres	900 kg
Allonge 15 mètres	1650 kg

3 ALLONGES

Pour déterminer la capacité de charge de la grue lorsqu'on utilise les allonges ou la section à télescopage mécanique de la flèche et que la flèche n'est pas complètement sortie, il faut se reporter à l'angle de levage flèche et non pas à la portée.

4 POULIE SUPPLEMENTAIRE SUR TETE DE FLECHE

Lorsqu'on utilise la poulie supplémentaire sur la tête de flèche, la capacité de levage ne dépasse pas 3800 daN, quelle que soit la configuration de la machine.



5 CAPACITES DE CHARGE SUR PNEUS

Dans la configuration de chargement sur pneus la rotation de la structure supérieure est admise uniquement en limitant l'angle de levage de la flèche télescopique aux 70°

TRAGKRAFT:

Das gesamte schwebende Gewicht, einschließlich das Gewicht des Hubzubehörs, welches der Kran bei bestimmten Auslegerlängen, Schwenkbereich und Auslegerwinkel, für eine bestimmte Abstützung und bei einer gewissen Schwenkungsgestaltung in idealem Sicherheitszustand heben kann.

TRAGBEREICH:

Der waagerechte Abstand gemessen vom Rotationsmittelpunkt der Strukturaufbauten zur Seilrolle an der Auslegerspitze gesenkten Senkrechten.

AUSLEGERWINKEL BEI BELASTUNG:

Der durch die zentrale Längsachse der Schnittes des Auslegeraufstandes und die waagerechte Achse gebildete Winkel, der nach dem Heben der Nennlast unter Einhaltung des Nennlastbereiches erreicht wird.

ERHEBUNG AUSLEGERSPITZE:

Der senkrecht gemessene Abstand vom Boden zur Achse der Seilrolle an der Auslegerspitze.

FREISCHWEBENDE LAST:

Die angehobene, frei schwebende Last ohne fremde, direkt einwirkende Kräfte außer der des Tragkabels.

ARBEITSBEREICH:

Der innerhalb eines Kreises um den Rotationsmittelpunkt gemessene Bereich, gemäß Angaben in der Tabelle des Betriebsbereiches.

VOLL AUSGEFAHRENE STABILISATOREN:

Alle vier Hebeböcke der Stabilisatoren sind vollkommen ausgefahren und der Kran wird auf den vier Abstützfüßen mit vollkommen vom Boden gelösten Rädern gehoben.

HALB-AUSGEFAHRENE STABILISATOREN:

Alle vier Hebeböcke der Stabilisatoren sind in mittlerer Länge ausgefahren und der Kran wird auf den vier Abstützfüßen mit vollkommen vom Boden gelösten Rädern gehoben.

EINGEZOGENE STABILISATOREN:

Alle vier Hebeböcke der Stabilisatoren sind in vollkommen eingezogen und der Kran wird auf den vier Abstützfüßen mit vollkommen vom Boden gelösten Rädern gehoben.

ANWEISUNG

Für den korrekten Einsatz des Krans bitten wir Sie Bezug auf die Betriebsanleitung zu nehmen.

- Die angegebenen Tragkräfte des Krans sind für die hier beschriebene Maschine in dem Zustand gültig, in dem sie gebaut und ursprünglich geliefert wird. Sie können nur dann angesetzt werden, wenn alle im vorliegenden Handbuch angegebenen Vorschriften strikt eingehalten werden. Jegliche Änderung an der Maschine oder die Benutzung anderer als die angegebenen Zubehörteile ist als unbefugt anzusehen.
- Je nach der durchzuführenden Arbeit und bei nicht idealen Arbeitsbedingungen, muss der Bediener von Mal zu Mal eine mögliche Verminderung der Tragkraft berücksichtigen. Diese Bedingungen umfassen die Standfläche, das Schwingen der Last, plötzliche oder aussetzende Stillstände während der Lastenbewegung und andere Faktoren, welche die Stabilität beeinflussen könnten, ebenso wie die elektrischen Versorgungskabel, schlechte Witterungsverhältnisse, Wind, eine gefährliche Umgebung, die Erfahrung des Bedienungspersonals, usw.
- Die Tragkräfte des Krans beziehen sich auf frei schwebende Lasten bei ausgeglichener, auf einem festen und ebenen Untergrund stehender Maschine. Je nach Beschaffenheit des Untergrundes könnte es sich als erforderlich erweisen Stahlprofil-Abstützungen unter dem Stabilisator einzusetzen, um die Last so zu verteilen, dass verhindert wird, dass die Grenzwerte der Untergrund-Tragfähigkeit überschritten werden. Lasten dürfen nicht waagrecht, egal in welche Richtung, am Boden entlang gezogen werden.
- Eine seitliche Belastung der Maschine oder das Schwenken der Last können ein Nachgeben oder das Kippen der Maschine selbst verursachen. Diese seitliche Belastung kann durch ein nicht ausgeglichenes Anheben, eine nicht ausgeglichene Schwingung, das Schleifen einer Last, plötzliche Beschleunigung oder Verlangsamung der Schwingung, das Einwirken der Windstärke gegen die Last oder das Gefüge des Auslegers, Schub der Last verursacht werden.
- Die belasteten Auslegerwinkel bei bestimmten Auslegerlängen ermöglichen nur eine annähernde Angabe des Betriebsbereiches. Aufgrund der Biegung des Auslegers während der Lastenhebung vom Boden, könnte der Auslegerwinkel vor der Belastung größer ausfallen.
- Die Betriebstragkräfte beziehen sich auf ein korrekt gemessenes Seilzugsystem. Überzählige Züge müssen beseitigt werden. Mehr Züge als erfordert (siehe Festigkeitstabelle Metallkabel) müssen als überschüssig gesehen und entsprechend berechnet werden.
- Die Maschinenausrichtung oder der Betrieb bei Radius- oder Auslegerlänge über dem angegebenen Maximalwert oder unter dem angegebenen Mindestwert ist weder vorgesehen noch zulässig.
- Falls einer oder beide Parameter in Bezug auf Radius oder Auslegerlänge unter die im Tragkraft-Diagramm fallen, muss die niedrigste der Radius- oder Auslegerlänge entsprechende Tragkraft eingehalten werden; sich dabei auf den unmittelbar über oder unter den im Diagramm angegebenen Parameter des Radius beziehen oder auf den unmittelbar über oder unter den im Diagramm angegebenen Parameter der Auslegerlänge.
- Die Ausrichtung oder der Betrieb der Verlängerungen oder der Ausleger mit Auslegerwinkel über dem angegebenen Maximalwert oder unter dem angegebenen Mindestwert ist weder vorgesehen noch zulässig.

HINWEIS

1 TRAGFÄHIGKEIT

Die Berechnungen der vorliegenden Diagramme basieren auf der Norm EN13000. Die angegebenen Werte sind für Maschinen gültig, die unter den von den Kategorien S0-HC1 vorgesehenen Bedingungen eingesetzt werden. Bei den angegebenen Belastungen handelt es sich um die Maximalwerte, die durch die Herstellungsgarantie abgedeckt werden, wenn die Maschine unter den in der entsprechenden Betriebs- und Instandhaltungsanleitung vorgesehenen Bedingungen und Einschränkungen eingesetzt wird. Die Werte der Tragfähigkeit werden in Tonnen angegeben und das Gewicht der Seilblöcke und des anderen für die Materialbewegung verwendeten Zubehörs muss von den angegebenen Belastungswerten den nachstehenden Spezifikationen gemäß abgezogen werden.

2 REDUZIERUNG DER BETRIEBSBELASTUNGSWERTE

Wird die Last mit dem Hauptausleger und der seitlich mit Bügeln befestigten oder am Auslegekopf montierter Verlängerung gehoben, müssen die unten genannten Werte vom in der Tabelle angegebenen Belastungswert abgezogen werden.

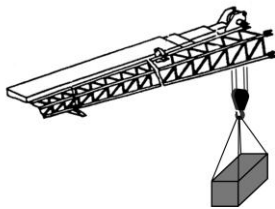

Verlängerung von 8 Metern	600 kg
Verlängerung von 15 Metern	800 kg

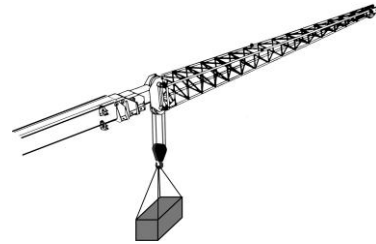

Verlängerung von 8 Metern	900 kg
Verlängerung von 15 Metern	1650 kg

3 VERLÄNGERUNGEN

Um die Belastungsfähigkeit des Krans bestimmen zu können, wenn man die Verlängerungen oder den mechanischen Auszugsbereich des Auslegers verwendet und der Ausleger dabei nicht vollkommen ausgefahren ist, muss man auf den Hebewinkel des Auslegers Bezug nehmen und nicht auf den Arbeitsradius.

4 ZUSÄTZLICHE RIEMENSCHLEIBE AM AUSLEGERKOPF

Bei jeder Konfiguration der Maschine, bei der die zusätzliche Riemenscheibe am Auslegerkopf verwendet wird, ist die max. Hebeleistung jedenfalls auf 3800 daN begrenzt.



5 TRAGFÄHIGKEIT AUF REIFEN

In der Belastungskonfiguration auf Reifen ist ein Drehen des Strukturaufbaus nur zulässig, wenn der Hebewinkel des Teleskopauslegers auf folgende Werte beschränkt ist 70°

DEFINITIES

HIJSCAPACITEIT :

De totale hangende last, inclusief het gewicht van de hulpmiddelen voor het hanteren van de last, die de kraan op een veilige en ideale manier kan hijsen rekening houdend met de lengte, de vlucht en de hoek van de giek en met een bepaalde opstelling van de stempels (uithouders) en het draagstel.

VLUCHT :

De horizontale afstand die gemeten wordt vanaf het middelpunt van de draaibeweging van het draagstel tot aan de verticale van de op de giekkop doorgebogen schijvenas.

HOEK VAN DE GIEK MET LAST :

De hoek die gevormd wordt door de middelste lengteas van de giek en de horizontale as nadat de nominale last is gehesen rekening houdend met de nominale vlucht.

HOOGTE VAN HET GIEKEINDE :

De verticale afstand die gemeten wordt vanaf de bodem waarop de kraan staat tot aan de schijvenas op de giekkop.

VRIJHANGENDE LAST :

Een last die vrij hangt, zonder dat er directe krachten van buitenaf op worden uitgeoefend, behalve die van de hijslier.

BEDRIJFSZONES:

De zone binnen de cirkel die gevormd wordt rondom de centrale draaiaas van het draagstel zoals vermeld in de grafiek van de hijszone.

STEMPELS IN HELEMAAL UITGESCHOVEN STAND:

De stempeldragers zijn volledig uitgeschoven en de machine rust op de vier stempels zonder dat de wielen de bodem raken.

STEMPELS IN HALF UITGESCHOVEN STAND:

De stempeldragers zijn half uitgeschoven en de machine rust op de vier stempels zonder dat de wielen de bodem raken.

STABILISATOREN HELEMAAL INGETROKKEN:

De stempeldragers zijn volledig ingeschoven en de machine rust op de vier stempels zonder dat de wielen de bodem raken.

WAARSCHUWINGEN

Raadpleeg de gebruiksaanwijzingen voor een foutloze aanwending van de hijskraan.

- De vermelde capaciteiten gelden voor de machine zoals deze oorspronkelijk wordt gebouwd en geleverd. Deze capaciteiten gelden alleen als alle voorschriften die in dit document en in de gebruiksaanwijzingen staan, worden nageleefd. Geen enkele wijziging aan de machine of gebruik van andere dan de voorgeschreven hulpmiddelen, is toegestaan.
- De gebruiker zal aan de hand van het werk dat dient te worden gedaan en de al dan niet moeilijke omstandigheden waarin dit dient te gebeuren, telkens dienen te bepalen of de hijscapaciteiten al dan niet verminderen. Deze omstandigheden worden bepaald door factoren zoals de bodem waarop de hijskraan rust, de slingerbeweging van de last, plots stoppende lasten en andere factoren die de machine uit haar evenwicht kunnen brengen; de aanwezigheid van elektrische draden, slecht weer, wind, een gevaarlijke omgeving, ervaring van het personeel enz..
- De vermelde capaciteiten van de kraan gelden voor vrij hangende lasten die bevestigd zijn aan een perfect waterpas staande hijskraan op een stevige, stabiele en vlakke bodem. Afhankelijk van de aard van de bodem kan het nodig zijn stalen profielen onder de stempels te plaatsen om de last evenredig te verdelen en te voorkomen dat de limietwaarden van de draagsterkte van de bodem worden overschreden. Sleep nooit lasten horizontaal over de bodem, in geen enkele richting.
- Door de machine zijdelings te belasten en het slingeren van de last kan de machine doorzakken of omkantelen. Zijdelingse belasting van de machine kan worden veroorzaakt door hijsen met een machine die niet perfect recht staat, slingerbewegingen van een last die niet recht hangt, plots versnellen of vertragen van deze beweging, wind op de last en op de giek, duwkracht van de last zelf.
- De hoeken van de giek met last geven bij bepaalde giek lengtes slechts een vlucht bij benadering. De hoek van de giek voordat er een last aan wordt gehangen, kan groter worden door het doorbuigen van de giek wanneer deze de last van de bodem optilt.
- De hijscapaciteiten zijn geldig op voorwaarde dat lieren met de juiste, voorgeschreven afmetingen worden gebruikt. Te grote afmetingen dienen te worden herleid. Grotere afmetingen dan voorgeschreven (zie de tabel met lierweerstand) dienen als te groot te worden beschouwd en te worden berekend.
- Plaatsing of werking van de kraan met een giek- of vluchtlengte die het voorgeschreven maximum of minimum overschrijden, zijn niet voorzien en dus niet toegestaan.
- Als de vlucht- of giek lengte of beiden binnen de limieten van de capaciteitengrafiek vallen, dient men de laagste capaciteit voor deze vlucht en armlengte te nemen; neem de vluchtwaarde of armlengte onmiddellijk boven of onder de waarde in het diagram.
- Plaatsing of werking van verlengingen of gieken met giekhoeken die het voorgeschreven maximum of minimum overschrijden, zijn niet voorzien en dus niet toegestaan.

OPMERKINGEN

1 CAPACITEIT

De berekeningen in de hier vermelde grafieken zijn gebaseerd op de norm EN 13000. De vermelde waarden gelden voor machines die werken in de omstandigheden die voorzien zijn voor de categorieën S0-HC1. De vermelde lasten zijn de maximale lasten waarvoor de fabrieksgarantie geldt op voorwaarde dat de machine gebruikt wordt in de omstandigheden en volgens de limieten die zijn voorgeschreven in de handleiding met gebruiks- en onderhoudsaanwijzingen. De vermogens zijn uitgedrukt in ton; het gewicht van de katrollen en andere toebehoren voor de verplaatsing dienen te worden afgetrokken van de vermelde lasten zoals hieronder is uiteengezet.

2 VERMINDERDE CAPACITEITEN

Als de kraan hijst met de hoofdgiek en een verlenging aan de zijkant van deze giek of op de giekkop, dient men de hijscapaciteiten uit de onderstaande tabel af te leiden.

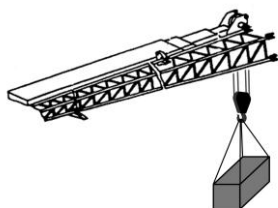

Verlenging 8 meter	600 kg
Verlenging 15 meter	800 kg

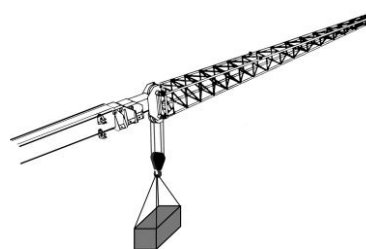

Verlenging 8 meter	900 kg
Verlenging 15 meter	1650 kg

3 VERLENGINGEN

Om de hijscapaciteit van de kraan te berekenen als verlengingen worden gebruikt of de uittrekbare delen van de giek en de giek is nog niet helemaal uitgetrokken, dient men rekening te houden met de giekhoek en niet met de vlucht.

4 AANVULLEND KATROL OP DE KOP VAN DE ARM

Voor iedere configuratie van de machine, wanneer het aanvullend katrol op de kop van de arm wordt gebruikt, is de maximum capaciteit beperkt tot 3800 daN.



5 BELASTING OP DE BANDEN

Voor de belasting op de banden is het draaien van de mast alleen toegestaan binnen de volgende hoeklimieten van de uitschuifbare giek 70°

CARGA DE TRABAJO :

Representa la carga total suspendida, incluso el peso de los accesorios de elevación, que la máquina puede levantar en condiciones ideales de seguridad para determinados valores de longitud, radio y ángulo de la pluma, en una específica configuración de los estabilizadores y de la rotación.

RADIO DE CARGA :

Representa la distancia horizontal medida desde el centro de rotación de la estructura superior hasta la vertical rebajada del eje de las poleas en la extremidad de la pluma.

ÁNGULO DE LA PLUMA BAJO CARGA :

Representa el ángulo determinado por el eje central longitudinal de la sección base de la pluma y por el eje horizontal, obtenido después de haber elevado la carga nominal, respetando el radio nominal de carga.

ELEVACIÓN EXTREMIDAD DE LA PLUMA :

Representa la distancia medida verticalmente del terreno al eje de las poleas en la extremidad de la pluma.

CARGA SUSPENDIDA LIBREMENTE :

Representa la carga suspendida libremente sin ninguna fuerza exterior aplicada directamente, excepto por la del cable de elevación.

ÁREAS DE TRABAJO :

Representa el área comprendida en el interior de un arco circular respecto al eje central de rotación de la estructura superior, como se indica en el diagrama de la zona operativa.

ESTABILIZADORES EN POSICIÓN DE MÁXIMA EXTENSIÓN :

Los largueros porta-estabilizadores están completamente extendidos y la máquina se eleva sobre los cuatro estabilizadores con las ruedas completamente levantadas del suelo.

ESTABILIZADORES EN EXTENSIÓN INTERMEDIA:

Los largueros porta-estabilizadores están extendidos en la posición intermedia y la máquina se eleva sobre los cuatro estabilizadores con las ruedas completamente levantadas del suelo.

ESTABILIZADORES COMPLETAMENTE CERRADOS:

Los largueros porta-estabilizadores están completamente cerrados y la máquina se eleva sobre los cuatro estabilizadores con las ruedas completamente levantadas del suelo.

ADVERTENCIAS

Para un uso correcto de la grúa móvil, consultar siempre el Manual de Uso.

- Las cargas mencionadas para la grúa se refieren a la presente máquina así como ha sido fabricada y suministrada originalmente. Estas cargas se pueden aplicar sólo si se respetan rigurosamente las instrucciones mencionadas en el presente documento y en el Manual de Uso. No se permite efectuar modificaciones a la máquina o emplear equipos diferentes de aquellos indicados.
- En función del trabajo que debe efectuarse y en presencia de condiciones de funcionamiento desfavorables, el usuario deberá determinar cada vez una posible reducción de la carga máxima de la grúa. Estas condiciones incluyen factores como la superficie de apoyo, las oscilaciones de la carga, las paradas repentinas de los movimientos de la carga o de otros factores que afectan su estabilidad, las presencia de líneas de alimentación eléctrica, el mal tiempo, el viento, el ambiente circunstante peligroso, la experiencia del personal, etc.
- Las cargas de la grúa se refieren a cargas suspendidas libremente con la máquina nivelada y ubicada sobre una superficie de apoyo sólida, estable y uniforme. En función del tipo de superficie de apoyo, podría ser necesario colocar soportes en perfil de acero debajo del estabilizador para distribuir la carga de tal manera que se evite la superación de los valores límites de la capacidad de soporte de la superficie misma. Las cargas no se deben arrastrar horizontalmente sobre el terreno en ninguna dirección.
- La carga lateral de la máquina y la oscilación de la carga pueden causar roturas o vuelcos de la máquina. La carga lateral de la máquina puede suceder debido a elevación de una carga en condiciones de desnivel, oscilaciones no a nivel, arrastre de una carga, aceleración o deceleración repentina de la oscilación, fuerza del viento sobre la carga y sobre la estructura de la pluma, empuje de la carga.
- Los ángulos de la pluma bajo carga a ciertas longitudes de pluma proporcionan sólo un radio de trabajo aproximado. El ángulo de la pluma, antes de la aplicación de la carga, podrá ser mayor debido a la flexión de la pluma durante la elevación de la carga del suelo.
- Las cargas de trabajo se refieren a un sistema de aparejo correcto de la cuerda. Es necesario reducir en número de guarnes en exceso. Un número de vueltas superior al necesario (véase tabla resistencia cuerdas) debe considerarse en exceso y ser calculado.
- No se permite o autoriza el posicionamiento o el funcionamiento a longitudes de radio o de pluma superiores al máximo o al mínimo mencionados.
- En el caso en que uno o ambos los parámetros de radio o longitud de la pluma estuvieran dentro de los límites indicados en el diagrama de cargas, elegir la carga más baja correspondiente al radio y a la longitud de la pluma; atenerse al parámetro de radio inmediatamente superior o inferior indicado en el diagrama, o al parámetro de longitud de la pluma inmediatamente superior o inferior indicado en el diagrama.
- No se permite o autoriza el posicionamiento o el funcionamiento de mecanismos de extensión o de plumas con ángulos de la pluma superiores al máximo o al mínimo mencionados.

NOTA

1 CARGA

Los cálculos relativos a los diagramas presentes se basan en la norma EN 13000. Los valores indicados son válidos para las máquinas utilizadas en las condiciones previstas por las categorías S0-HC1. Las cargas indicadas son aquellas máximas cubiertas por la garantía de fabricación cuando se emplea la máquina en las condiciones y dentro de los límites previstos por el relativo manual de uso y mantenimiento. Las cargas se expresan en toneladas y el peso de los motones y de otros accesorios para la elevación debe restarse de las cargas indicadas así como se menciona a continuación.

2 REDUCCIÓN DE LAS CARGAS DE TRABAJO

En caso de elevación con la pluma principal y el mecanismo de extensión plegado al lado o instalado en la extremidad de la pluma misma, restar los valores indicados abajo de la carga mencionada en la tabla.

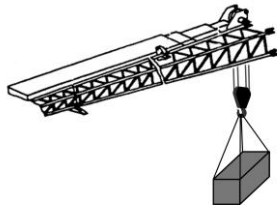

Mec.de extens. 8 Metros	600 kg
Mec.de extens. 15 Metros	800 kg

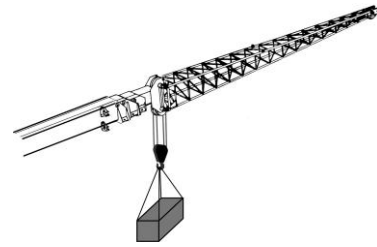

Mec.de extens. 8 Metros	900 kg
Mec.de extens. 15 Metros	1650 kg

3 MECANISMOS DE EXTENSIÓN

Para determinar la capacidad de carga de la grúa cuando se emplean los mecanismos de extensión o las secciones de extensión mecánica de la pluma y la pluma no ha sido extendida completamente, es necesario considerar el ángulo de elevación de la pluma y no el radio de trabajo.

4 POLEA SUPLEMENTARIA EN CABEZAL BRAZO

Para cada configuración de la máquina, cuando se usa la polea suplementaria en el cabezal brazo, la capacidad máxima de elevación está limitada a 3800 daN



5 CARGAS SOBRE NEUMÁTICOS

En la configuración de carga sobre neumáticos, la rotación de la estructura superior es admisible sólo limitando el ángulo de elevación de la pluma telescópica a 70°



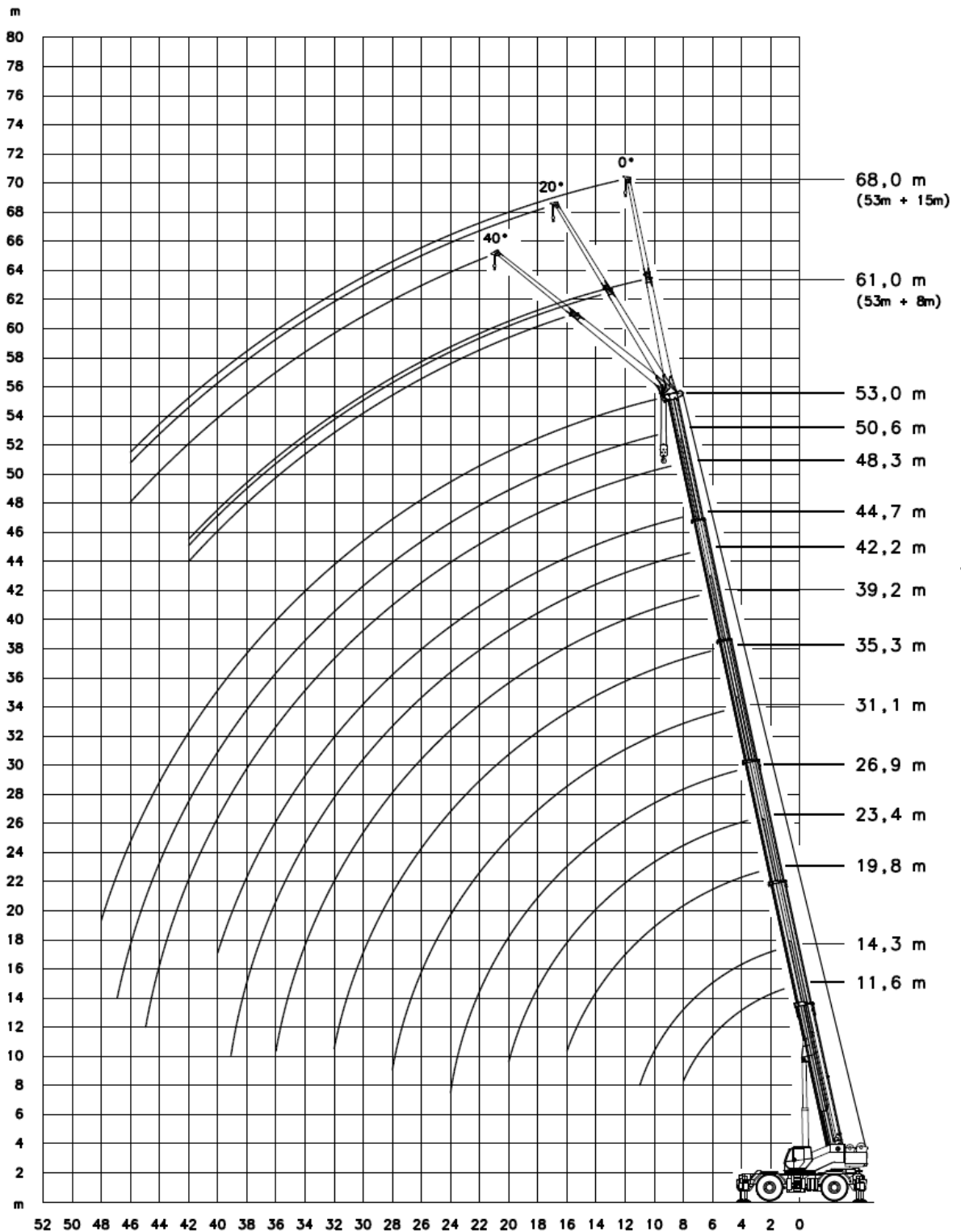
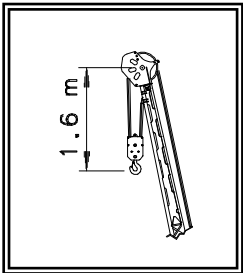
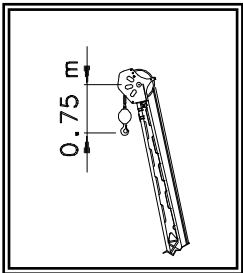
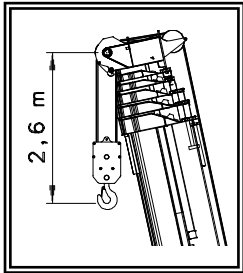

MAIN BOOM AND EXTENSIONS: HEIGHT, RADIUS AND BOOM LENGTHS

BRACCIO PRINCIPALE E PROLUNGHE: ALTEZZE, RAGGI E LUNGHEZZE BRACCIO
 FLECHE PRINCIPALE ET EXTENSIONS : HAUTEURS, PORTEES ET LONGUEURS DE FLECHE
 HAUPTAUSLEGER UND VERLÄNGERUNGEN: HÖHE, RADIUS UND LÄNGE DES ARMS
 HOOFDGIK EN VERLENGSTUKKEN: HOOGTE, BEREIK EN LENGTE VAN DE GIJK
 PLUMA PRINCIPAL Y ALARGADORES: ALTURAS, RADIOS Y LONGITUDES PLUMA



USE THE LOAD CURVE TOGETHER WITH THE PROVIDED CHARTS

UTILIZZARE IL DIAGRAMMA DI PORTATA INSIEME ALLE APPOSITE TABELLE
 UTILISER LE DIAGRAMME DES CAPACITES AVEC LES TABLEAUX SPECIAUX
 DIE TRAGKRAFT-DIAGRAMME GEMEINSAM MIT DEN ENTSPRECHENDEN TABELLE VERWENDEN
 GEBUIK DE LASTTABEL SAMEN MET DE SPECIALE TABELLEN
 UTILIZAR EL DIAGRAMA DE CAPACIDAD JUNTO CON LAS TABLAS ADECUADAS

MAIN HOIST ARGANO PRINCIPALE - TREUIL PRINCIPAL - HAUPTHUBWERK HOOFDLIER – CABRESTANTE PRINCIPAL						
ROPE FUNÈ – CABLE – SEIL KABEL - CABLE Ø 18 mm - R min 323.0 kN L 300 m		ROPE MAXIMUM ADMISSIBLE PULL TIRO MASSIMO AMMISSIBILE FUNÈ – CABLE TRACTION MAXIMALE ADMISSIBLE MAXIMAL ZULASSIGE SEILZUG – KABEL MAXIMAAL TOELAATBARE KRACHT TRACCION MAXIMA ADMISIBILE CABLE 8000 daN				
HOIST MAXIMUM SINGLE LINE PULL TIRO MASSIMO ARGANO CON SINGOLA FUNÈ – TRACTION MAXIMALE TREUIL SUR BRIN SIMPLE MAXIMAL HUBWERKZUG MIT EINFACHEM STRANG – LIER MAXIMAAL KRACHT MET ENKELE KABEL TRACCION MAXIMA CABRESTANTE DE UN SOLO RAMAL DE CABLE						
LAYER – STRATO COUCHE – LAGE LAAG - CAPA	N	1	2	3	4	5
PULL – TIRO TRACTION – ZUG KRACHT - TRACCION	daN	10000 	9300 	8600 	8000 	7500 
ROPE – FUNÈ CABLE – SEIL KABEL - CABLE	m	52	108	168	233	302

AUXILIARY HOIST ARGANO AUSILIARIO - TREUIL AUXILIARE - ZUSATZHUBWERK HULPLIER – CABRESTANTE AUXILIAR						
ROPE FUNÈ – CABLE – SEIL KABEL - CABLE Ø 15 mm - R min 196.3 kN L 175 m		ROPE MAXIMUM ADMISSIBLE PULL TIRO MASSIMO AMMISSIBILE FUNÈ – CABLE TRACTION MAXIMALE ADMISSIBLE MAXIMAL ZULASSIGE SEILZUG – KABEL MAXIMAAL TOELAATBARE KRACHT TRACCION MAXIMA ADMISIBILE CABLE 3800 daN				
HOIST MAXIMUM SINGLE LINE PULL TIRO MASSIMO ARGANO CON SINGOLA FUNÈ – TRACTION MAXIMALE TREUIL SUR BRIN SIMPLE MAXIMAL HUBWERKZUG MIT EINFACHEM STRANG – LIER MAXIMAAL KRACHT MET ENKELE KABEL TRACCION MAXIMA CABRESTANTE DE UN SOLO RAMAL DE CABLE						
LAYER – STRATO COUCHE – LAGE LAAG - CAPA	N	1	2	3	4	5
PULL – TIRO TRACTION – ZUG KRACHT - TRACCION	daN	5100	4700	4350	4050	3800
ROPE – FUNÈ CABLE – SEIL KABEL - CABLE	m	32	68	106	147	191

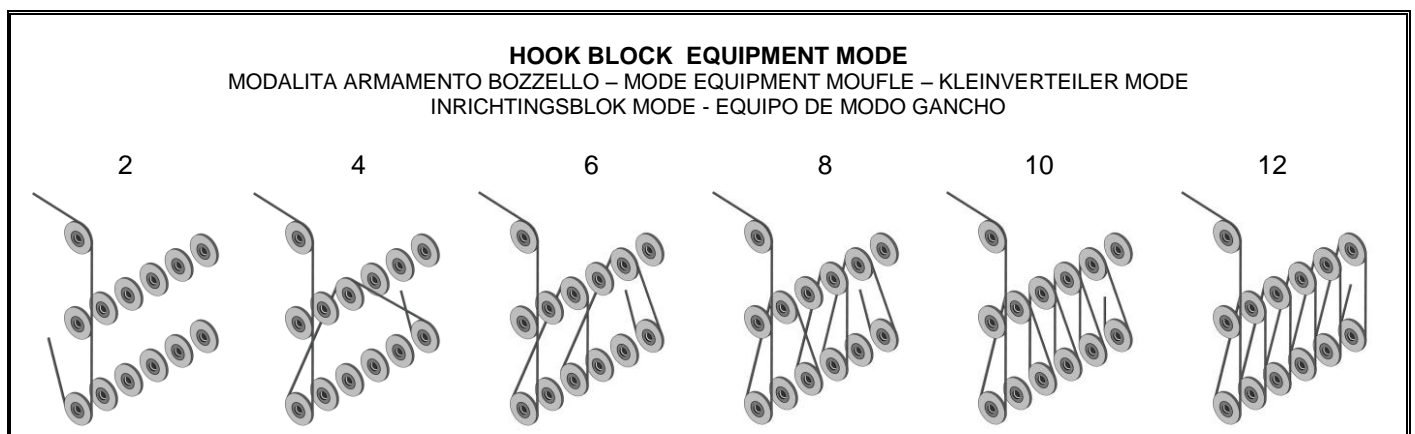

OPERATING AREAS ON OUTRIGGERS

ZONE DI FUNZIONAMENTO SU STABILIZZATORI
 ZONES DE FONCTIONNEMENT SUR STABILISATEURS
 BETRIEBSBREICHE AUF STABILISATOREN
 WERKBEREIK OP STEMPELPOTEN
 ZONAS DE FUNCIONAMIENTO EN ESTABILIZADORES

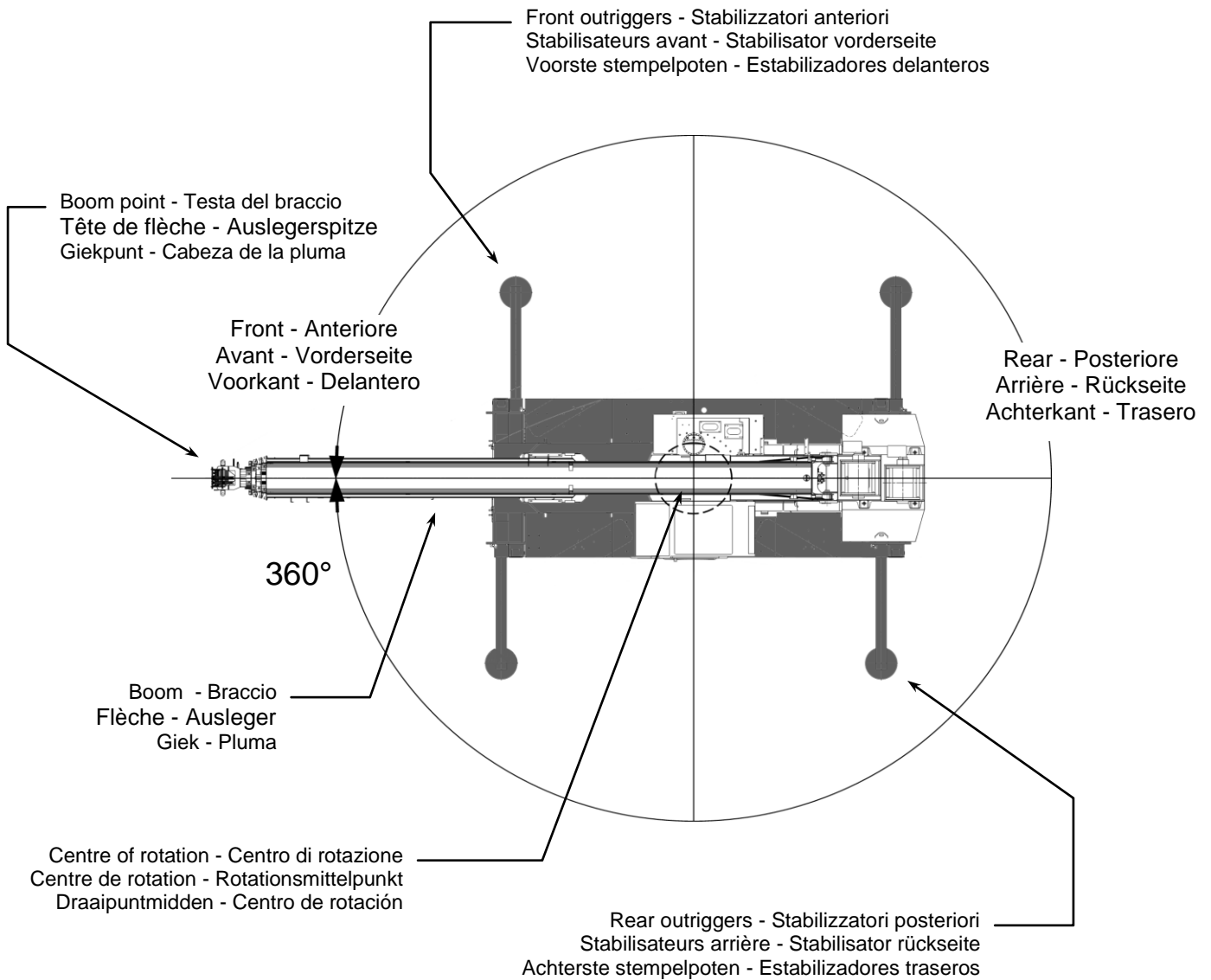

OUTRIGGERS POSITIONING

POSIZIONAMENTO STABILIZZATORI
POSITIONNEMENT STABILISATEURS
AUSRICHTEN AUF DEN STABILISATOREN
PLAATSING OP STEMPELPOTEN
POSICIONAMIENTO ESTABILIZADORES

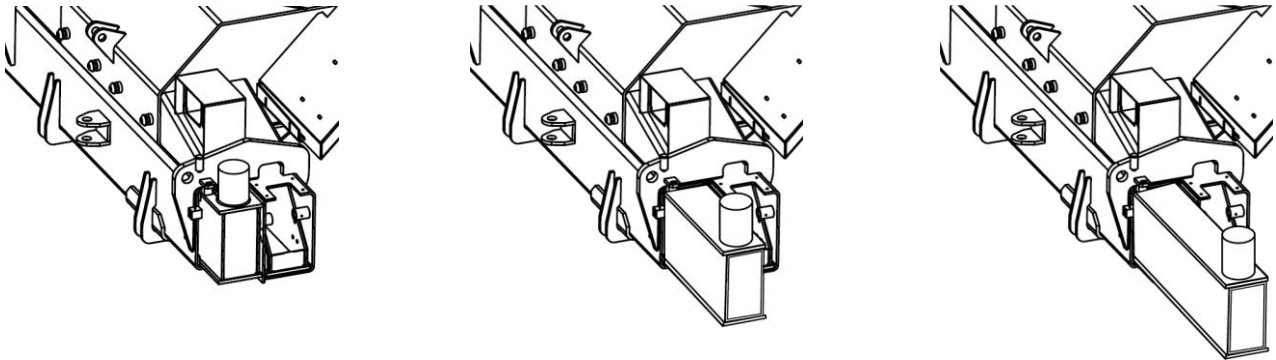

- The position of outriggers completely or partially extended, or completely closed will be correct only when the outriggers' beam will be locked with the pins.
Before extending or closing the outriggers **DO NOT FORGET** to remove the locking pins.
- La posizione delle travi stabilizzatori in estensione totale, intermedia o chiusa risulterà corretta solamente se le travi stesse saranno bloccate tramite gli appositi perni.
Prima di retrarre o estendere le travi stabilizzatori **NON DIMENTICARE** di togliere i perni di bloccaggio.
- La position des poutres stabilisateurs en extension totale, partielle ou complètement fermée est correcte uniquement lorsque les poutres sont bloquées par les goujons.
Avant d'actionner le commande des poutres **NE PAS OUBLIERS** d'enlever les pivots.
- Die Position der voll ausgefahrenen, sich in der mittleren Position befindlichen oder im geschlossenen Zustand befindlichen Stabilisatoren, ist nur dann korrekt, wenn deren Träger durch die entsprechenden Sperrbolzen blockiert sind.
Vor dem Einfahren bzw. Ausfahren der Träger der Stabilisatoren **NICHT VERGESSEN**, die Sperrbolzen zu entfernen.
- De positie van de volledig of gedeeltelijk uitgeschoven of volledig ingeschoven stempelpoten zal alleen correct zijn als de balken van de stempelpoten geborgd zijn met de pennen. **VERGEET NIET** deze borgpennen te verwijderen voordat u de balken van de stempelpoten in- of uitschuift.
- La posición de estabilización en extensión total, intermedia o cerrada resultará correcta solamente si las vigas de los estabilizadores estarán bloqueadas por medio de los pernos apropiados.
Antes de retraer o extender las vigas de los estabilizadores **NO OLVIDAR** sacar los pernos de bloqueo.

OPERATING AREAS ON TYRES
 ZONE DI FUNZIONAMENTO SU PNEUMATICI
 ZONES DE FONCTIONNEMENT SUR PNEUMATIQUES
 BETRIEBSBREICHE AUF REIFEN
 WERKBEREIK OP BANDEN
 ZONAS DE FUNCIONAMIENTO EN PNEUMÁTICOS

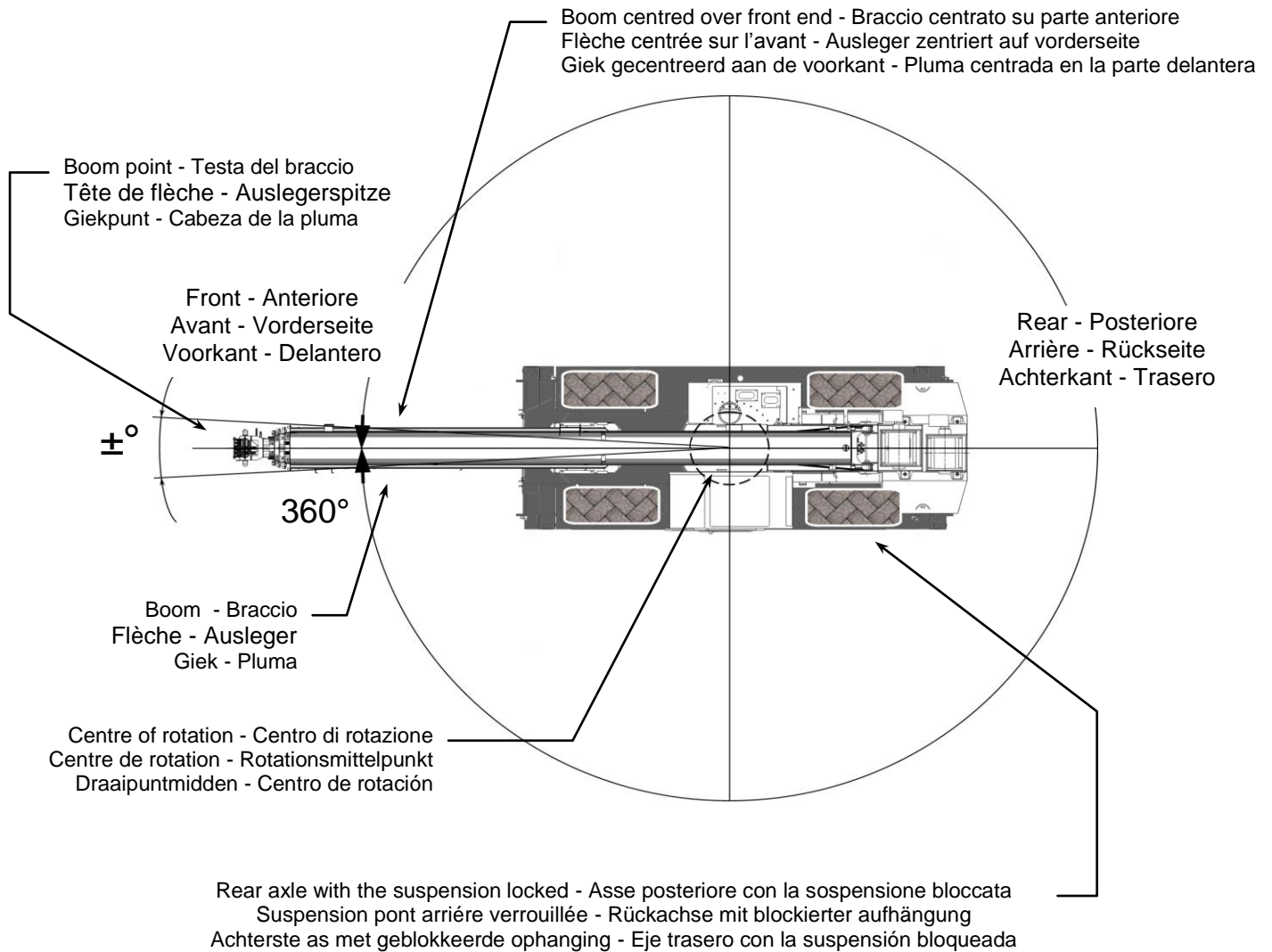

INDEX OF SYMBOLS

INDICE SIMBOLI - INDEX DES SYMBOLES - SYMBOLVERZEICHNIS
OVERZICHT VAN DE SYMBOLEN - ÍNDICE SÍMBOLOS











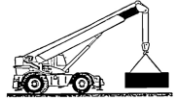
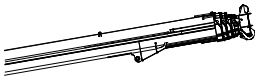
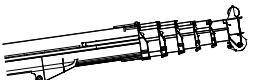

	<p>Outriggers fully extended - Stabilizzatori completamente estesi Stabilisateurs en extension totale - Voll ausgefahrene Abstützungen Stempelpoten volledig uitgeschoven - Estabilizadores completamente extendidos</p>
	<p>Outriggers half-extended - Stabilizzatori parzialmente estesi Stabilisateurs en extension partielle - Teilweise ausgefahrene Stempelpoten half uitgeschoven - Estabilizadores parzialmente extendidos</p>
	<p>Outriggers unextended - Stabilizzatori chiusi Stabilisateurs fermée - Eingefahrene Abstützungen Stempelpoten ingeschoven - Estabilizadores cerrados</p>
	<p>Load capacity on wheels - Portate su pneumatici Charges sur pneus - Tragfähigkeit auf Reifen Lastcapaciteit op banden - Capacidades en neumáticos</p>
	<p>Traveling speed - Velocità traslazione Vitesse de translation - Bewegungsgeschwindigkeit Bewegingssnelheid - Velocidad desplazamiento</p>
	<p>Telescopic boom - Braccio telescopico Flèche télescopique - Teleskoparm Uitschuifbare giek - Pluma telescópica</p>
	<p>Telescoping boom mode - Modo di sfilo del braccio Mode d'extension (télescopage) de la flèche - Ausfahrmodus des Auslegers Uitschuifwijze van de giek - Modo de apertura de la pluma</p>
	<p>% of extraction of the telescopic elements - % di sfilo degli elementi telescopici % d'extension des éléments télescopiques - Ausfahrhub der Teleskopelemente in % % uitschuiving van de telescopische elementen - % de apertura de los elementos telescópicos</p>
	<p>Counterweight - Contrappeso Contrepoids - Gegengewicht Tegengewicht - Contrapeso</p>
	<p>Upperstructure angle rotation - Angolo rotazione sovrastruttura Angle rotation structure du dessus - Drehwinkel des Strukturaufbaus Draaihoek bovenbouw - Ángulo rotación estructura superior</p>
	<p>Upperstructure rotation lock - Rotazione sovrastruttura bloccata Blocage rotation structure du dessus - Bolzen des Strukturaufbaus Handmatig blokkeer bovenbouw - Bloqueo rotación estructura superior</p>
	<p>Moment limiting device program - Programma limitatore di momento Programme limiteur de moment - Momentbegrenzer-Programm Momentbegrenzerprogramma - Programa limitador de momento</p>
	<p>Extension / Jib - Prolunga / Jib Extension / Jib - Verlängerung / Jib Verlengstuk / Hulpgiek - Alargador / Jib</p>
	<p>No load handling in these zones - Non movimentare carichi in queste zone Ne pas manipuler de charges dans ces zones - Keine Lasten in diesen Bereichen bewegen Geen lasten verplaatsen in deze zone - No desplazar cargas en estas zonas</p>

TABLE OF CONTENTS

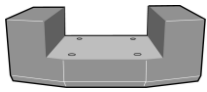
INDICE - TABLE DES MATIERES - INHALTSVERZEICHNIS - INHOUD - ÍNDICE

RT100A.C.SAS.00.00  **“1” Loads on outriggers fully extended over 360°**
 Carichi su stabilizzatori completamente estesi su 360° Lasten op volledig uitgeschoven stempels bij 360°
 Charges sur stabilisateurs extension totale sur 360° Cargas sobres estabilizadores completamente extendidos a 360°
 Lasten auf voll ausgefahrenen Stabilisatoren bei 360°

RT100B.C.SAS.00.00  **“2” Loads on outriggers fully extended over 360°**
 Carichi su stabilizzatori completamente estesi su 360° Lasten op volledig uitgeschoven stempels bij 360°
 Charges sur stabilisateurs extension totale sur 360° Cargas sobres estabilizadores completamente extendidos a 360°
 Lasten auf voll ausgefahrenen Stabilisatoren bei 360°

RT100A.C.SIS.00.00  **“1” Loads on outriggers intermediate extended over 360°**
 Carichi su stabilizzatori intermedi su 360° Lasten op half uitgeschoven stempels bij 360°
 Charges sur stabilisateurs extension partielle sur 360° Cargas sobres estabilizadores intermedios a 360°
 Lasten auf halb ausgefahrenen Stabilisatoren bei 360°

RT100B.C.SIS.00.00  **“2” Loads on outriggers intermediate extended over 360°**
 Carichi su stabilizzatori intermedi su 360° Lasten op half uitgeschoven stempels bij 360°
 Charges sur stabilisateurs extension partielle sur 360° Cargas sobres estabilizadores intermedios a 360°
 Lasten auf halb ausgefahrenen Stabilisatoren bei 360°

RT100A.C.SCS.00.00  **“1” Loads on outriggers not extended over 360°**
 Carichi su stabilizzatori chiusi su 360° Lasten op niet uitgeschoven tempels bij 360°
 Charges sur stabilisateurs fermée sur 360° Cargas sobres estabilizadores cerrados a 360°
 Lasten auf teilweise Erstreckung Stabilisatoren bei 360°

RT100B.C.SCS.00.00  **“2” Loads on outriggers not extended over 360°**
 Carichi su stabilizzatori chiusi su 360° Lasten op niet uitgeschoven tempels bij 360°
 Charges sur stabilisateurs fermée sur 360° Cargas sobres estabilizadores cerrados a 360°
 Lasten auf teilweise Erstreckung Stabilisatoren bei 360°

RT100A.C.PNS.29.00  **“1” Loads on wheels static over 360°**
 Carichi su pneumatici statiche su 360° Lasten op banden, statisch bij 360°
 Charges sur pneumatique statique sur 360° Cargas sobre neumáticos estáticos a 360°
 Lasten auf rädern statisch bei 360°



RT100B.C.PNS.29.00  **“2” Loads on wheels static over 360°**
 Carichi su pneumatici statiche su 360° Lasten op banden, statisch bij 360°
 Charges sur pneumatique statique sur 360° Cargas sobre neumáticos estáticos a 360°
 Lasten auf rädern statisch bei 360°







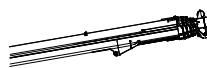
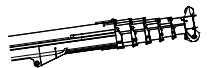
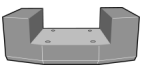





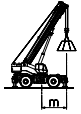





RT100A.A.PNM.29.00  **“1” Loads on wheels 2Km/h over front 0°**
 Carichi su pneumatici a 2 Km/h settore frontale 0° Lasten op banden met 2 Km/h vooraan 0°
 Charges sur pneumatique 2 Km/h sur l'avant 0° Cargas sobre neumáticos a 2 Km/h sector delantero 0°
 Lasten auf rädern 2 Km/h auf Vorderseite 0°

RT100B.A.PNM.29.00  **“2” Loads on wheels 2Km/h over front 0°**
 Carichi su pneumatici a 2 Km/h settore frontale 0° Lasten op banden met 2 Km/h vooraan 0°
 Charges sur pneumatique 2 Km/h sur l'avant 0° Cargas sobre neumáticos a 2 Km/h sector delantero 0°
 Lasten auf rädern 2 Km/h auf Vorderseite 0°

RT100A.C.SAS.08.00  **“2” Loads on outriggers fully extended over 360° extension 8m.**
 Carichi su stabilizzatori completamente estesi con prolunga 8m. Lasten op volledig uitgeschoven stempels en een verlenging van 8m.
 Charges sur stabilisateurs extension totale avec extension 8m. Cargas sobres estabilizadores completamente extendidos con extensión de 8m.
 Lasten auf voll ausgefahrenen Stabilisatoren gitterspitze 8m.

RT100.C.SAS.15.00  **“2” Loads on outriggers fully extended over 360° extension 15m.**
 Carichi su stabilizzatori completamente estesi con prolunga 15m. Lasten op volledig uitgeschoven stempels en een verlenging van 15m.
 Charges sur stabilisateurs extension totale avec extension 15m. Cargas sobres estabilizadores completamente extendidos con extensión de 15m.
 Lasten auf voll ausgefahrenen Stabilisatoren gitterspitze 15m.



					
8.00 m x 8.00 m	11.60 m ÷ 44.70 m	T6 Off	10.00 t	360°	CODE 01







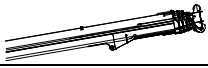
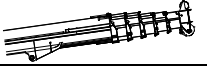
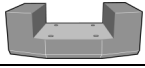











	t2 = 0% t3 = 0% t4 = 0% t5 = 0% t6 = 0%		t2 = 16.7% t3 = 16.7% t4 = 0% t5 = 0% t6 = 0%		t2 = 33.3% t3 = 33.3% t4 = 0% t5 = 0% t6 = 0%		t2 = 50% t3 = 50% t4 = 0% t5 = 0% t6 = 0%		t2 = 66.6% t3 = 66.6% t4 = 0% t5 = 0% t6 = 0%		t2 = 83.3% t3 = 83.3% t4 = 0% t5 = 0% t6 = 0%		
	11.60 m		14.30 m		17.00 m		19.80 m		22.50 m		25.20 m		
													
	Max 78.0°	90.00	Max 78.0°	74.00	Max 78.0°	57.00	Max 78.0°	55.00	Max 78.0°	45.70	Max 78.0°	40.25	
3.0	65.6	90.00	70.6	74.00	73.8	57.00	76.2	55.00	77.9	45.70			3.0
3.5	62.8	82.60	68.4	68.90	72.1	52.60	74.6	51.10	76.6	42.25	78.0	40.25	3.5
4.0	59.8	73.50	66.2	64.00	70.2	49.05	73.1	47.35	75.2	39.40	76.9	37.70	4.0
4.5	56.8	65.30	63.9	59.60	68.4	45.75	71.6	44.20	73.9	36.90	75.7	35.15	4.5
5.0	53.6	58.80	61.6	55.80	66.5	42.85	70.0	41.25	72.5	34.80	74.5	33.00	5.0
6.0	46.7	49.00	56.7	49.50	62.7	38.20	66.8	36.75	69.8	30.80	72.1	29.30	6.0
7.0	38.7	42.00	51.6	42.00	58.7	34.40	63.6	32.90	67.0	27.65	69.7	26.35	7.0
8.0	28.5	36.80	45.9	36.70	54.6	31.25	60.2	29.80	64.2	24.85	67.2	23.65	8.0
9.0			39.6	30.60	50.1	28.55	56.7	27.35	61.2	22.60	64.6	21.50	9.0
10.0			32.0	24.75	45.3	26.35	53.0	24.85	58.2	20.75	62.0	19.65	10.0
11.0			21.9	20.45	40.1	20.20	49.1	19.95	55.1	19.05	59.4	18.15	11.0
12.0					34.0	17.00	45.0	16.80	51.8	17.60	56.6	16.75	12.0
13.0					26.7	14.50	40.5	14.30	48.3	14.15	53.8	15.45	13.0
14.0					16.0	12.55	35.5	12.30	44.7	12.15	50.8	12.05	14.0
15.0							29.6	10.65	40.7	10.55	47.7	10.40	15.0
16.0							22.3	9.30	36.4	9.15	44.5	9.05	16.0
17.0									31.6	8.00	41.0	7.90	17.0
18.0									25.8	7.05	37.2	6.90	18.0
19.0									18.2	6.15	33.0	6.05	19.0
20.0											28.3	5.30	20.0
21.0											22.5	4.65	21.0
22.0											14.5	4.00	22.0
23.0													23.0
24.0													24.0
25.0													25.0
26.0													26.0
27.0													27.0
28.0													28.0
29.0													29.0
30.0													30.0
31.0													31.0
32.0													32.0
33.0													33.0
34.0													34.0
35.0													35.0
36.0													36.0
37.0													37.0
38.0													38.0
39.0													39.0
40.0													40.0
41.0													41.0
42.0													42.0
43.0													43.0
44.0													44.0
45.0													45.0
46.0													46.0
47.0													47.0
48.0													48.0
49.0													49.0
50.0													50.0
	0°	31.20	0°	20.40	0°	12.40	0°	9.20	0°	6.00	0°	4.00	



RT100







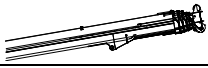
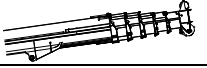
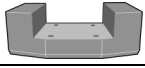











EN13000

TEREX®

					
8.00 m x 8.00 m	11.60 m ÷ 44.70 m	T6 Off	10.00 t	360°	CODE 01

	t2 = 94% t3 = 94% t4 = 0% t5 = 0% t6 = 0%		t2 = 94% t3 = 94% t4 = 25% t5 = 25% t6 = 0%		t2 = 94% t3 = 94% t4 = 50% t5 = 50% t6 = 0%		t2 = 94% t3 = 94% t4 = 75% t5 = 75% t6 = 0%		t2 = 94% t3 = 94% t4 = 94% t5 = 94% t6 = 0%		t2 = 100% t3 = 100% t4 = 100% t5 = 100% t6 = 0%		
	26.90 m		31.10 m		35.30 m		39.50 m		42.70 m		44.70 m		
													
	Max 78.0°	34.60	Max 78.0°	28.80	Max 78.0°	22.05	Max 78.0°	17.30	Max 78.0°	13.75	Max 78.0°	11.55	
3.0													3.0
3.5													3.5
4.0	77.7	34.60											4.0
4.5	76.6	32.25	78.5	28.80									4.5
5.0	75.5	30.25	77.5	27.25									5.0
6.0	73.3	26.95	75.6	24.05	77.4	22.05							6.0
7.0	71.0	24.00	73.7	21.65	75.7	19.85	77.2	17.30					7.0
8.0	68.8	21.80	71.7	19.55	74.0	17.80	75.7	16.05	76.8	13.75			8.0
9.0	66.4	19.65	69.8	17.60	72.3	16.25	74.2	14.75	75.4	12.90	76.1	11.55	9.0
10.0	64.0	18.05	67.8	16.10	70.6	14.85	72.7	13.50	74.0	11.95	74.8	10.85	10.0
11.0	61.6	16.55	65.8	14.70	68.8	13.60	71.2	12.55	72.6	11.00	73.4	10.05	11.0
12.0	59.1	15.15	63.7	13.60	67.0	12.40	69.6	11.55	71.2	10.25	72.1	9.30	12.0
13.0	56.5	14.05	61.6	12.55	65.2	11.45	68.0	10.70	69.8	9.50	70.7	8.60	13.0
14.0	53.9	13.00	59.4	11.60	63.4	10.65	66.4	9.85	68.3	8.90	69.3	8.05	14.0
15.0	51.1	10.35	57.2	10.75	61.6	9.85	64.8	9.10	66.8	8.25	67.9	7.45	15.0
16.0	48.3	9.00	55.0	10.00	59.7	9.15	63.2	8.50	65.4	7.75	66.5	6.95	16.0
17.0	45.2	7.85	52.6	9.30	57.7	8.45	61.5	7.85	63.9	7.20	65.1	6.40	17.0
18.0	42.0	6.85	50.2	7.50	55.8	7.90	59.9	7.30	62.3	6.70	63.7	5.95	18.0
19.0	38.6	6.00	47.7	6.60	53.7	7.35	58.1	6.80	60.8	6.20	62.2	5.45	19.0
20.0	34.9	5.25	45.1	5.80	51.7	6.85	56.4	6.35	59.2	5.75	60.7	5.05	20.0
21.0	30.7	4.60	42.3	5.15	49.5	5.55	54.6	5.95	57.6	5.35	59.2	4.70	21.0
22.0	26.0	3.95	39.4	4.55	47.3	5.00	52.8	5.55	56.0	5.00	57.7	4.35	22.0
23.0	20.0	3.40	36.3	4.00	45.0	4.45	50.9	5.15	54.3	4.65	56.2	4.00	23.0
24.0	10.9	2.90	32.9	3.55	42.6	3.95	49.0	4.50	52.6	4.30	54.6	3.70	24.0
25.0			29.2	3.10	40.0	3.55	47.0	3.85	50.9	4.00	53.0	3.45	25.0
26.0			24.9	2.70	37.4	3.15	44.9	3.45	49.1	3.70	51.3	3.20	26.0
27.0			19.6	2.35	34.5	2.75	42.7	3.10	47.3	3.50	49.6	2.90	27.0
28.0			12.1	2.00	31.4	2.45	40.5	2.75	45.4	3.25	47.9	2.70	28.0
29.0					27.9	2.15	38.1	2.50	43.4	2.80	46.1	2.45	29.0
30.0					24.0	1.85	35.7	2.20	41.4	2.40	44.3	2.30	30.0
31.0					19.3	1.60	33.0	1.90	39.2	2.10	42.3	2.05	31.0
32.0					12.9	1.35	30.1	1.65	37.0	1.85	40.4	1.90	32.0
33.0							26.9	1.45	34.6	1.65	38.3	1.70	33.0
34.0							23.3	1.20	32.1	1.40	36.1	1.55	34.0
35.0							19.1	1.00	29.4	1.20	33.8	1.25	35.0
36.0							13.4	0.80	26.4	1.05	31.3	1.05	36.0
37.0									23.0	0.85	28.7	0.85	37.0
38.0									19.1	0.70	25.7	0.70	38.0
39.0									14.0	0.50	22.4	0.55	39.0
40.0													40.0
41.0													41.0
42.0													42.0
43.0													43.0
44.0													44.0
45.0													45.0
46.0													46.0
47.0													47.0
48.0													48.0
49.0													49.0
50.0													50.0
 min	0°	2.80	0°	2.00	0°	1.35	0°	0.80	0°	0.50	0°	0.30	 min



					
8.00 m x 8.00 m	11.60 m ÷ 53.00 m	T6 On	10.00 t	360°	CODE 02





	t2 = 0% t3 = 0% t4 = 0% t5 = 0% t6 = 0%		t2 = 0% t3 = 0% t4 = 23% t5 = 23% t6 = 23%		t2 = 0% t3 = 0% t4 = 47% t5 = 47% t6 = 47%		t2 = 0% t3 = 0% t4 = 66.6% t5 = 66.6% t6 = 66.6%		t2 = 23% t3 = 23% t4 = 66.6% t5 = 66.6% t6 = 66.6%		t2 = 47% t3 = 47% t4 = 66.6% t5 = 66.6% t6 = 66.6%		
	11.60 m		17.40 m		23.40 m		28.30 m		32.00 m		36.00 m		
													
	Max 78.0°	12.40	Max 78.0°	11.80	Max 78.0°	11.75	Max 78.0°	12.25	Max 78.0°	12.35	Max 78.0°	12.35	
3.0	65.6	12.40	74.2	11.80	78.4	11.75							3.0
3.5	62.8	12.75	72.4	11.95	77.1	11.90							3.5
4.0	59.8	13.20	70.6	12.15	75.8	12.05	78.3	12.25					4.0
4.5	56.8	13.70	68.9	12.35	74.5	12.20	77.3	12.40					4.5
5.0	53.6	14.25	67.0	12.60	73.2	12.35	76.3	12.60	77.9	12.35			5.0
6.0	46.7	15.85	63.3	13.10	70.6	12.70	74.1	12.95	76.1	12.60	77.6	12.35	6.0
7.0	38.7	18.00	59.4	13.70	68.0	13.10	72.0	13.35	74.2	12.95	76.0	12.60	7.0
8.0	28.5	18.00	55.4	14.50	65.3	13.55	69.8	13.75	72.3	13.25	74.3	12.65	8.0
9.0			51.1	15.40	62.5	14.05	67.6	13.05	70.4	13.20	72.6	12.55	9.0
10.0			46.5	14.95	59.6	14.70	65.4	11.80	68.5	12.95	70.9	12.40	10.0
11.0			41.4	14.35	56.7	14.80	63.1	10.90	66.5	12.40	69.2	12.30	11.0
12.0			35.8	13.80	53.6	13.80	60.8	10.00	64.5	11.45	67.5	12.05	12.0
13.0			29.1	13.40	50.4	13.00	58.4	9.20	62.5	10.60	65.7	11.60	13.0
14.0			20.1	13.00	47.0	12.25	55.9	8.50	60.4	9.90	64.0	10.80	14.0
15.0					43.4	11.60	53.4	7.95	58.3	9.20	62.1	10.20	15.0
16.0					39.5	11.00	50.7	7.30	56.1	8.70	60.3	9.50	16.0
17.0					35.3	10.55	48.0	6.85	53.9	8.10	58.4	8.95	17.0
18.0					30.5	10.05	45.1	6.35	51.6	7.60	56.5	8.40	18.0
19.0					24.7	9.60	42.1	6.00	49.3	7.20	54.5	7.95	19.0
20.0					17.1	9.00	38.8	5.60	46.8	6.75	52.5	7.45	20.0
21.0							35.3	5.25	44.2	6.35	50.4	7.10	21.0
22.0							31.5	4.95	41.5	6.05	48.3	6.70	22.0
23.0							27.1	4.60	38.6	5.70	46.1	6.35	23.0
24.0							21.8	4.35	35.5	5.40	43.8	6.05	24.0
25.0							14.6	4.10	32.2	5.15	41.3	5.00	25.0
26.0									28.5	4.85	38.8	4.60	26.0
27.0									24.2	4.60	36.1	4.20	27.0
28.0									18.9	4.40	33.2	3.85	28.0
29.0									11.2	4.20	30.0	3.60	29.0
30.0											26.4	3.25	30.0
31.0											22.4	3.00	31.0
32.0											17.3	2.75	32.0
33.0											9.6	2.50	33.0
34.0													34.0
35.0													35.0
36.0													36.0
37.0													37.0
38.0													38.0
39.0													39.0
40.0													40.0
41.0													41.0
42.0													42.0
43.0													43.0
44.0													44.0
45.0													45.0
46.0													46.0
47.0													47.0
48.0													48.0
49.0													49.0
50.0													50.0
	0°	18.00	0°	13.00	0°	9.00	0°	4.10	0°	4.20	0°	2.50	

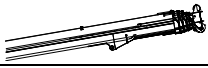
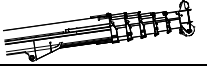
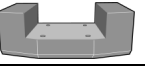

RT100

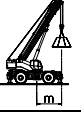
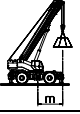





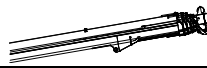
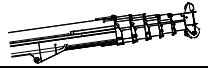
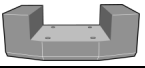





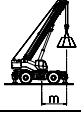





EN13000



					
8.00 m x 8.00 m	11.60 m ÷ 53.00 m	T6 On	10.00 t	360°	CODE 02

	39.20 m		42.20 m		43.70 m		48.30 m		50.60 m		53.00 m		
	Max 78.0°	12.05	Max 78.0°	10.60	Max 78.0°	10.80	Max 78.0°	9.25	Max 78.0°	7.75	Max 78.0°	6.50	
3.0													3.0
3.5													3.5
4.0													4.0
4.5													4.5
5.0													5.0
6.0													6.0
7.0	77.1	12.05											7.0
8.0	75.6	12.05	76.7	10.60	77.1	10.80							8.0
9.0	74.1	11.95	75.3	10.60	75.8	10.90	77.2	9.25					9.0
10.0	72.6	11.95	73.8	10.60	74.4	11.00	75.9	9.25	76.6	7.75			10.0
11.0	71.0	11.80	72.4	10.60	73.0	11.15	74.7	9.25	75.4	7.70	76.1	6.50	11.0
12.0	69.4	11.70	71.0	10.50	71.6	11.15	73.5	9.30	74.2	7.65	75.0	6.50	12.0
13.0	67.9	11.00	69.5	10.50	70.2	10.40	72.2	9.20	73.0	7.65	73.9	6.20	13.0
14.0	66.3	10.30	68.1	10.20	68.8	9.70	71.0	8.70	71.8	7.60	72.7	5.90	14.0
15.0	64.6	9.60	66.6	9.60	67.4	9.10	69.7	8.20	70.6	7.45	71.6	5.55	15.0
16.0	63.0	9.05	65.1	8.95	66.0	8.50	68.4	7.65	69.4	7.10	70.4	5.30	16.0
17.0	61.3	8.50	63.5	8.40	64.5	8.00	67.1	7.25	68.2	6.80	69.3	5.05	17.0
18.0	59.6	8.00	62.0	7.95	63.0	7.45	65.8	6.85	67.0	6.40	68.1	4.85	18.0
19.0	57.9	7.55	60.4	7.45	61.5	7.05	64.5	6.45	65.7	6.05	66.9	4.55	19.0
20.0	56.1	7.10	58.8	7.10	60.0	6.55	63.2	6.10	64.5	5.70	65.7	4.35	20.0
21.0	54.3	6.70	57.2	6.70	58.5	6.20	61.8	5.75	63.2	5.40	64.5	4.15	21.0
22.0	52.4	6.35	55.5	6.35	56.9	5.75	60.4	5.40	61.9	5.05	63.3	3.95	22.0
23.0	50.5	6.05	53.9	6.00	55.3	5.40	59.0	5.10	60.6	4.80	62.1	3.80	23.0
24.0	48.6	5.70	52.1	4.95	53.6	5.10	57.6	4.85	59.3	4.50	60.9	3.60	24.0
25.0	46.5	4.70	50.4	4.55	52.0	4.80	56.2	4.60	57.9	4.25	59.6	3.40	25.0
26.0	44.4	4.30	48.5	4.10	50.2	4.50	54.7	4.35	56.5	4.05	58.3	3.25	26.0
27.0	42.2	4.00	46.7	3.75	48.5	3.65	53.2	4.10	55.2	3.85	57.0	3.10	27.0
28.0	40.0	3.60	44.7	3.40	46.7	3.30	51.7	3.85	53.7	3.65	55.7	2.95	28.0
29.0	37.5	3.30	42.7	3.10	44.8	3.00	50.2	3.60	52.3	3.45	54.4	2.80	29.0
30.0	35.0	3.00	40.6	2.80	42.9	2.75	48.6	3.00	50.8	3.25	53.0	2.65	30.0
31.0	32.3	2.75	38.4	2.55	40.8	2.45	47.0	2.75	49.3	2.95	51.6	2.55	31.0
32.0	29.3	2.50	36.1	2.30	38.7	2.20	45.3	2.45	47.8	2.65	50.2	2.40	32.0
33.0	26.0	2.25	33.7	2.05	36.5	1.95	43.5	2.25	46.2	2.35	48.8	2.20	33.0
34.0	22.2	2.05	31.0	1.85	34.2	1.75	41.8	2.00	44.6	2.15	47.3	2.00	34.0
35.0	17.6	1.85	28.2	1.65	31.7	1.55	39.9	1.80	42.9	1.95	45.8	1.85	35.0
36.0	11.1	1.65	25.0	1.45	29.0	1.35	38.0	1.65	41.2	1.75	44.2	1.70	36.0
37.0			21.3	1.25	26.0	1.20	35.9	1.45	39.4	1.55	42.6	1.55	37.0
38.0			16.9	1.10	22.7	1.00	33.8	1.30	37.5	1.40	41.0	1.40	38.0
39.0			10.7	0.95	18.8	0.85	31.5	1.15	35.6	1.25	39.3	1.30	39.0
40.0							29.1	0.95	33.5	1.10	37.5	1.15	40.0
41.0							26.5	0.85	31.4	0.95	35.6	1.00	41.0
42.0							23.5	0.70	29.0	0.80	33.7	0.80	42.0
43.0							20.2	0.55	26.5	0.65	31.6	0.70	43.0
44.0							16.1	0.45	23.7	0.55	29.4	0.55	44.0
45.0							10.5	0.30	20.6	0.45	27.1	0.45	45.0
46.0									16.9	0.30	24.5	0.35	46.0
47.0									12.0	0.20	21.6	0.25	47.0
48.0											18.3	0.15	48.0
49.0													49.0
50.0													50.0
 min	0°	1.65	0°	0.95	0°	0.80	0°	0.30	0°	0.20	14°STOP		 min



					
5.30 m x 8.00 m	11.60 m ÷ 44.70 m	T6 Off	10.00 t	360°	CODE 03







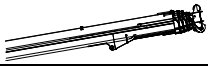
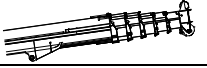
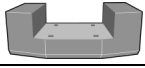







	t2 = 0% t3 = 0% t4 = 0% t5 = 0% t6 = 0%		t2 = 16.7% t3 = 16.7% t4 = 0% t5 = 0% t6 = 0%		t2 = 33.3% t3 = 33.3% t4 = 0% t5 = 0% t6 = 0%		t2 = 50% t3 = 50% t4 = 0% t5 = 0% t6 = 0%		t2 = 66.6% t3 = 66.6% t4 = 0% t5 = 0% t6 = 0%		t2 = 83.3% t3 = 83.3% t4 = 0% t5 = 0% t6 = 0%		
	11.60 m		14.30 m		17.00 m		19.80 m		22.50 m		25.20 m		
													
	Max 78.0°	90.00	Max 78.0°	74.00	Max 78.0°	57.00	Max 78.0°	55.00	Max 78.0°	45.70	Max 78.0°	40.25	
3.0	65.6	90.00	70.6	74.00	73.8	57.00	76.2	55.00	77.9	45.70			3.0
3.5	62.8	82.60	68.4	68.90	72.1	52.60	74.6	51.10	76.6	42.25	78.0	40.25	3.5
4.0	59.8	73.50	66.2	64.00	70.2	49.05	73.1	47.35	75.2	39.40	76.9	37.70	4.0
4.5	56.8	65.30	63.9	59.60	68.4	45.75	71.6	44.20	73.9	36.90	75.7	35.15	4.5
5.0	53.6	58.65	61.6	55.80	66.5	42.85	70.0	41.25	72.5	34.80	74.5	33.00	5.0
6.0	46.7	39.55	56.7	39.05	62.7	38.20	66.8	36.75	69.8	30.80	72.1	29.30	6.0
7.0	38.7	29.20	51.6	28.75	58.7	28.45	63.6	28.25	67.0	27.65	69.7	26.35	7.0
8.0	28.5	22.70	45.9	22.35	54.6	22.05	60.2	21.85	64.2	21.70	67.2	23.65	8.0
9.0			39.6	17.90	50.1	17.70	56.7	17.50	61.2	17.45	64.6	17.20	9.0
10.0			32.0	14.75	45.3	14.45	53.0	14.30	58.2	14.15	62.0	14.05	10.0
11.0			21.9	12.20	40.1	12.05	49.1	11.90	55.1	11.75	59.4	11.65	11.0
12.0					34.0	10.15	45.0	10.00	51.8	9.85	56.6	9.75	12.0
13.0					26.7	8.55	40.5	8.40	48.3	8.30	53.8	8.20	13.0
14.0					16.0	7.25	35.5	7.15	44.7	7.05	50.8	6.95	14.0
15.0							29.6	6.05	40.7	5.95	47.7	5.90	15.0
16.0							22.3	5.15	36.4	5.05	44.5	5.00	16.0
17.0									31.6	4.30	41.0	4.15	17.0
18.0									25.8	3.55	37.2	3.50	18.0
19.0									18.2	3.00	33.0	2.90	19.0
20.0											28.3	2.35	20.0
21.0											22.5	1.90	21.0
22.0											14.5	1.45	22.0
23.0													23.0
24.0													24.0
25.0													25.0
26.0													26.0
27.0													27.0
28.0													28.0
29.0													29.0
30.0													30.0
31.0													31.0
32.0													32.0
33.0													33.0
34.0													34.0
35.0													35.0
36.0													36.0
37.0													37.0
38.0													38.0
39.0													39.0
40.0													40.0
41.0													41.0
42.0													42.0
43.0													43.0
44.0													44.0
45.0													45.0
46.0													46.0
47.0													47.0
48.0													48.0
49.0													49.0
50.0													50.0
 min	0°	18.50	0°	10.80	0°	7.20	0°	4.20	0°	2.50	0°	1.20	 min



RT100





EN13000

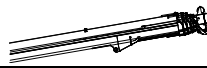
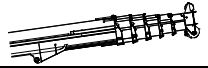
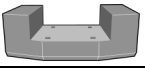

					
5.30 m x 8.00 m	11.60 m ÷ 44.70 m	T6 Off	10.00 t	360°	CODE 03

	26.90 m		31.10 m		35.30 m		39.50 m		42.70 m		44.70 m		
	Max 78.0°		Max 78.0°		Max 78.0°		Max 78.0°		Max 78.0°		Max 78.0°		
3.0													3.0
3.5													3.5
4.0	77.7	34.60											4.0
4.5	76.6	32.25	78.5	28.80									4.5
5.0	75.5	30.25	77.5	27.25									5.0
6.0	73.3	26.95	75.6	24.05	77.4	22.05							6.0
7.0	71.0	24.00	73.7	21.65	75.7	19.85	77.2	17.30					7.0
8.0	68.8	21.80	71.7	19.55	74.0	17.80	75.7	16.05	76.8	13.75			8.0
9.0	66.4	17.15	69.8	17.60	72.3	16.25	74.2	14.75	75.4	12.90	76.1	11.55	9.0
10.0	64.0	14.00	67.8	16.10	70.6	14.85	72.7	13.50	74.0	11.95	74.8	10.85	10.0
11.0	61.6	11.60	65.8	12.25	68.8	13.60	71.2	12.55	72.6	11.00	73.4	10.05	11.0
12.0	59.1	9.70	63.7	10.35	67.0	10.85	69.6	11.55	71.2	10.25	72.1	9.30	12.0
13.0	56.5	8.15	61.6	8.80	65.2	9.30	68.0	10.70	69.8	9.50	70.7	8.60	13.0
14.0	53.9	6.90	59.4	7.50	63.4	8.00	66.4	8.40	68.3	8.90	69.3	8.05	14.0
15.0	51.1	5.85	57.2	6.45	61.6	6.90	64.8	7.25	66.8	8.25	67.9	7.45	15.0
16.0	48.3	4.95	55.0	5.55	59.7	6.05	63.2	6.35	65.4	6.50	66.5	6.95	16.0
17.0	45.2	4.10	52.6	4.75	57.7	5.20	61.5	5.50	63.9	5.70	65.1	6.40	17.0
18.0	42.0	3.45	50.2	4.05	55.8	4.50	59.9	4.80	62.3	5.00	63.7	5.05	18.0
19.0	38.6	2.85	47.7	3.45	53.7	3.85	58.1	4.20	60.8	4.40	62.2	4.45	19.0
20.0	34.9	2.35	45.1	2.90	51.7	3.35	56.4	3.70	59.2	3.90	60.7	3.90	20.0
21.0	30.7	1.85	42.3	2.45	49.5	2.90	54.6	3.20	57.6	3.40	59.2	3.45	21.0
22.0	26.0	1.45	39.4	2.05	47.3	2.45	52.8	2.80	56.0	3.00	57.7	3.00	22.0
23.0	20.0	1.05	36.3	1.65	45.0	2.10	50.9	2.40	54.3	2.65	56.2	2.65	23.0
24.0	10.9	0.70	32.9	1.30	42.6	1.75	49.0	2.05	52.6	2.25	54.6	2.25	24.0
25.0			29.2	1.00	40.0	1.40	47.0	1.75	50.9	1.95	53.0	1.95	25.0
26.0			24.9	0.70	37.4	1.15	44.9	1.45	49.1	1.65	51.3	1.65	26.0
27.0			19.6	0.45	34.5	0.85	42.7	1.20	47.3	1.40	49.6	1.40	27.0
28.0			12.1	0.20	31.4	0.60	40.5	0.95	45.4	1.15	47.9	1.15	28.0
29.0					27.9	0.40	38.1	0.70	43.4	0.90	46.1	0.90	29.0
30.0					24.0	0.20	35.7	0.50	41.4	0.70	44.3	0.70	30.0
31.0							33.0	0.30	39.2	0.50	42.3	0.50	31.0
32.0							30.1	0.10	37.0	0.30	40.4	0.35	32.0
33.0									34.6	0.15	38.3	0.15	33.0
34.0													34.0
35.0													35.0
36.0													36.0
37.0													37.0
38.0													38.0
39.0													39.0
40.0													40.0
41.0													41.0
42.0													42.0
43.0													43.0
44.0													44.0
45.0													45.0
46.0													46.0
47.0													47.0
48.0													48.0
49.0													49.0
50.0													50.0
	0°	0.60	12°STOP		24°STOP		30°STOP		34°STOP		38°STOP		

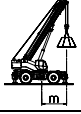
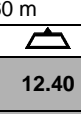
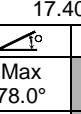
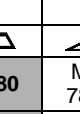
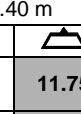
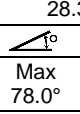
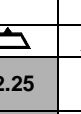
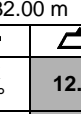
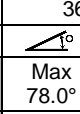
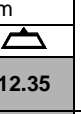
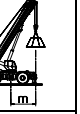
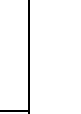

					
5.30 m x 8.00 m	11.60 m ÷ 53.00 m	T6 On	10.00 t	360°	CODE 04







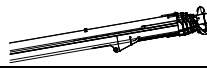
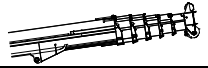
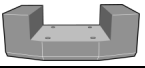



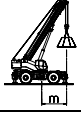



	t2 = 0% t3 = 0% t4 = 0% t5 = 0% t6 = 0%		t2 = 0% t3 = 0% t4 = 23% t5 = 23% t6 = 23%		t2 = 0% t3 = 0% t4 = 47% t5 = 47% t6 = 47%		t2 = 0% t3 = 0% t4 = 66.6% t5 = 66.6% t6 = 66.6%		t2 = 23% t3 = 23% t4 = 66.6% t5 = 66.6% t6 = 66.6%		t2 = 47% t3 = 47% t4 = 66.6% t5 = 66.6% t6 = 66.6%		
	11.60 m		17.40 m		23.40 m		28.30 m		32.00 m		36.00 m		
													
	Max 78.0°		Max 78.0°		Max 78.0°		Max 78.0°		Max 78.0°		Max 78.0°		
3.0	65.6	12.40	74.2	11.80	78.4	11.75							3.0
3.5	62.8	12.75	72.4	11.95	77.1	11.90							3.5
4.0	59.8	13.20	70.6	12.15	75.8	12.05	78.3	12.25					4.0
4.5	56.8	13.70	68.9	12.35	74.5	12.20	77.3	12.40					4.5
5.0	53.6	14.25	67.0	12.55	73.2	12.35	76.3	12.60	77.9	12.30			5.0
6.0	46.7	15.85	63.3	13.10	70.6	12.70	74.1	12.95	76.1	12.60	77.6	12.35	6.0
7.0	38.7	18.00	59.4	13.70	68.0	13.10	72.0	13.35	74.2	12.90	76.0	12.60	7.0
8.0	28.5	18.00	55.4	14.50	65.3	13.55	69.8	13.75	72.3	13.25	74.3	12.65	8.0
9.0			51.1	15.40	62.5	14.05	67.6	13.05	70.4	13.20	72.6	12.55	9.0
10.0			46.5	14.95	59.6	14.70	65.4	11.80	68.5	12.95	70.9	12.40	10.0
11.0			41.4	14.35	56.7	14.80	63.1	10.90	66.5	12.40	69.2	12.30	11.0
12.0			35.8	13.80	53.6	13.80	60.8	10.00	64.5	11.45	67.5	12.05	12.0
13.0			29.1	10.90	50.4	11.50	58.4	9.20	62.5	10.60	65.7	11.60	13.0
14.0			20.1	9.35	47.0	10.15	55.9	8.50	60.4	9.90	64.0	9.60	14.0
15.0					43.4	9.05	53.4	7.95	58.3	9.20	62.1	8.45	15.0
16.0					39.5	8.05	50.7	7.30	56.1	8.70	60.3	7.55	16.0
17.0					35.3	7.25	48.0	6.85	53.9	7.10	58.4	6.70	17.0
18.0					30.5	6.55	45.1	6.35	51.6	6.30	56.5	6.00	18.0
19.0					24.7	5.90	42.1	6.00	49.3	5.70	54.5	5.30	19.0
20.0					17.1	5.35	38.8	5.60	46.8	5.20	52.5	4.80	20.0
21.0							35.3	5.25	44.2	4.70	50.4	4.30	21.0
22.0							31.5	4.95	41.5	4.25	48.3	3.85	22.0
23.0							27.1	4.60	38.6	3.85	46.1	3.50	23.0
24.0							21.8	4.35	35.5	3.50	43.8	3.10	24.0
25.0							14.6	3.60	32.2	3.15	41.3	2.80	25.0
26.0									28.5	2.90	38.8	2.50	26.0
27.0									24.2	2.60	36.1	2.25	27.0
28.0									18.9	2.35	33.2	2.00	28.0
29.0									11.2	2.10	30.0	1.75	29.0
30.0											26.4	1.55	30.0
31.0											22.4	1.35	31.0
32.0											17.3	1.15	32.0
33.0											9.6	0.95	33.0
34.0													34.0
35.0													35.0
36.0													36.0
37.0													37.0
38.0													38.0
39.0													39.0
40.0													40.0
41.0													41.0
42.0													42.0
43.0													43.0
44.0													44.0
45.0													45.0
46.0													46.0
47.0													47.0
48.0													48.0
49.0													49.0
50.0													50.0
 min	0°	18.00	0°	9.30	0°	5.30	0°	3.60	0°	2.00	0°	0.90	 min

RT100

EN13000



					
5.30 m x 8.00 m	11.60 m ÷ 53.00 m	T6 On	10.00 t	360°	CODE 04

	39.20 m		42.20 m		43.70 m		48.30 m		50.60 m		53.00 m		
	Max 78.0°		Max 78.0°		Max 78.0°		Max 78.0°		Max 78.0°		Max 78.0°		
3.0													3.0
3.5													3.5
4.0													4.0
4.5													4.5
5.0													5.0
6.0													6.0
7.0	77.1	12.05											7.0
8.0	75.6	12.05	76.7	10.60	77.1	10.80							8.0
9.0	74.1	11.95	75.3	10.60	75.8	10.90	77.2	9.25					9.0
10.0	72.6	11.95	73.8	10.60	74.4	11.00	75.9	9.25	76.6	7.75			10.0
11.0	71.0	11.80	72.4	10.60	73.0	11.15	74.7	9.25	75.4	7.70	76.1	6.50	11.0
12.0	69.4	11.70	71.0	10.50	71.6	11.15	73.5	9.30	74.2	7.65	75.0	6.50	12.0
13.0	67.9	11.00	69.5	10.50	70.2	10.40	72.2	9.20	73.0	7.65	73.9	6.20	13.0
14.0	66.3	10.30	68.1	9.05	68.8	9.70	71.0	8.70	71.8	7.60	72.7	5.90	14.0
15.0	64.6	8.20	66.6	7.95	67.4	7.85	69.7	8.20	70.6	7.45	71.6	5.55	15.0
16.0	63.0	7.25	65.1	7.05	66.0	6.95	68.4	7.65	69.4	7.10	70.4	5.30	16.0
17.0	61.3	6.45	63.5	6.25	64.5	6.15	67.1	6.35	68.2	6.80	69.3	5.05	17.0
18.0	59.6	5.75	62.0	5.45	63.0	5.35	65.8	5.65	67.0	6.40	68.1	4.85	18.0
19.0	57.9	5.05	60.4	4.85	61.5	4.75	64.5	5.05	65.7	5.20	66.9	4.55	19.0
20.0	56.1	4.55	58.8	4.30	60.0	4.25	63.2	4.50	64.5	4.65	65.7	4.35	20.0
21.0	54.3	4.05	57.2	3.85	58.5	3.75	61.8	4.05	63.2	4.15	64.5	4.15	21.0
22.0	52.4	3.60	55.5	3.40	56.9	3.35	60.4	3.60	61.9	3.75	63.3	3.95	22.0
23.0	50.5	3.25	53.9	3.05	55.3	2.95	59.0	3.20	60.6	3.35	62.1	3.35	23.0
24.0	48.6	2.90	52.1	2.70	53.6	2.60	57.6	2.90	59.3	3.00	60.9	3.00	24.0
25.0	46.5	2.55	50.4	2.35	52.0	2.25	56.2	2.55	57.9	2.65	59.6	2.70	25.0
26.0	44.4	2.25	48.5	2.05	50.2	2.00	54.7	2.25	56.5	2.35	58.3	2.40	26.0
27.0	42.2	2.00	46.7	1.80	48.5	1.70	53.2	2.00	55.2	2.10	57.0	2.10	27.0
28.0	40.0	1.75	44.7	1.55	46.7	1.45	51.7	1.75	53.7	1.85	55.7	1.85	28.0
29.0	37.5	1.50	42.7	1.30	44.8	1.25	50.2	1.50	52.3	1.60	54.4	1.65	29.0
30.0	35.0	1.30	40.6	1.10	42.9	1.05	48.6	1.30	50.8	1.40	53.0	1.40	30.0
31.0	32.3	1.10	38.4	0.90	40.8	0.85	47.0	1.10	49.3	1.20	51.6	1.25	31.0
32.0	29.3	0.90	36.1	0.70	38.7	0.65	45.3	0.90	47.8	1.00	50.2	1.05	32.0
33.0	26.0	0.75	33.7	0.55	36.5	0.45	43.5	0.75	46.2	0.85	48.8	0.85	33.0
34.0	22.2	0.55	31.0	0.40	34.2	0.30	41.8	0.60	44.6	0.70	47.3	0.70	34.0
35.0	17.6	0.40	28.2	0.25	31.7	0.15	39.9	0.45	42.9	0.55	45.8	0.55	35.0
36.0	11.1	0.25	25.0	0.10			38.0	0.30	41.2	0.40	44.2	0.40	36.0
37.0							35.9	0.15	39.4	0.25	42.6	0.25	37.0
38.0									37.5	0.15	41.0	0.15	38.0
39.0											39.3	0.05	39.0
40.0													40.0
41.0													41.0
42.0													42.0
43.0													43.0
44.0													44.0
45.0													45.0
46.0													46.0
47.0													47.0
48.0													48.0
49.0													49.0
50.0													50.0
 min	0°	0.10	25°STOP		31°STOP		35°STOP		37°STOP		39°STOP		 min

3.00 m x 8.00 m	11.60 m ÷ 44.70 m	T6 Off	10.00 t	360°	CODE 05

	t2 = 0% t3 = 0% t4 = 0% t5 = 0% t6 = 0%		t2 = 16.7% t3 = 16.7% t4 = 0% t5 = 0% t6 = 0%		t2 = 33.3% t3 = 33.3% t4 = 0% t5 = 0% t6 = 0%		t2 = 50% t3 = 50% t4 = 0% t5 = 0% t6 = 0%		t2 = 66.6% t3 = 66.6% t4 = 0% t5 = 0% t6 = 0%		t2 = 83.3% t3 = 83.3% t4 = 0% t5 = 0% t6 = 0%		
	11.60 m		14.30 m		17.00 m		19.80 m		22.50 m		25.20 m		
	Max 78.0°	68.45	Max 78.0°	63.35	Max 78.0°	57.00	Max 78.0°	55.00	Max 78.0°	45.70	Max 78.0°	40.25	
3.0	65.6	68.45	70.6	63.35	73.8	57.00	76.2	55.00	77.9	45.70			3.0
3.5	62.8	49.95	68.4	49.40	72.1	52.60	74.6	51.10	76.6	42.25	78.0	40.25	3.5
4.0	59.8	39.20	66.2	38.35	70.2	37.95	73.1	37.70	75.2	39.40	76.9	37.70	4.0
4.5	56.8	31.50	63.9	31.05	68.4	30.65	71.6	30.40	73.9	30.25	75.7	30.10	4.5
5.0	53.6	26.25	61.6	25.80	66.5	25.60	70.0	25.20	72.5	25.05	74.5	24.90	5.0
6.0	46.7	19.20	56.7	18.80	62.7	18.55	66.8	18.30	69.8	18.15	72.1	18.00	6.0
7.0	38.7	14.70	51.6	14.35	58.7	14.10	63.6	13.90	67.0	13.75	69.7	13.65	7.0
8.0	28.5	11.60	45.9	11.25	54.6	11.00	60.2	10.85	64.2	10.70	67.2	10.60	8.0
9.0			39.6	9.00	50.1	8.75	56.7	8.60	61.2	8.50	64.6	8.35	9.0
10.0			32.0	7.25	45.3	7.05	53.0	6.90	58.2	6.75	62.0	6.70	10.0
11.0			21.9	5.85	40.1	5.70	49.1	5.55	55.1	5.45	59.4	5.35	11.0
12.0					34.0	4.55	45.0	4.45	51.8	4.35	56.6	4.25	12.0
13.0					26.7	3.65	40.5	3.55	48.3	3.45	53.8	3.35	13.0
14.0					16.0	2.85	35.5	2.75	44.7	2.65	50.8	2.60	14.0
15.0							29.6	2.10	40.7	2.05	47.7	1.95	15.0
16.0							22.3	1.55	36.4	1.45	44.5	1.40	16.0
17.0									31.6	0.95	41.0	0.90	17.0
18.0									25.8	0.50	37.2	0.45	18.0
19.0									18.2	0.15	33.0	0.10	19.0
20.0													20.0
21.0													21.0
22.0													22.0
23.0													23.0
24.0													24.0
25.0													25.0
26.0													26.0
27.0													27.0
28.0													28.0
29.0													29.0
30.0													30.0
31.0													31.0
32.0													32.0
33.0													33.0
34.0													34.0
35.0													35.0
36.0													36.0
37.0													37.0
38.0													38.0
39.0													39.0
40.0													40.0
41.0													41.0
42.0													42.0
43.0													43.0
44.0													44.0
45.0													45.0
46.0													46.0
47.0													47.0
48.0													48.0
49.0													49.0
50.0													50.0
	0°	9.40	0°	5.00	0°	2.80	0°	0.90	18°STOP		33°STOP		



RT100







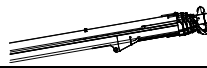
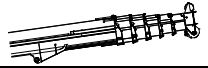
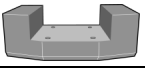









EN13000



3.00 m x 8.00 m	11.60 m ÷ 44.70 m	T6 Off	10.00 t	360°	CODE 05

	26.90 m		31.10 m		35.30 m		39.50 m		42.70 m		44.70 m		
	Max 78.0°	34.60	Max 78.0°	28.80	Max 78.0°	19.25	Max 78.0°	15.20	Max 78.0°	13.75	Max 78.0°	10.05	
3.0													3.0
3.5													3.5
4.0	77.7	34.60											4.0
4.5	76.6	32.25	78.5	28.80									4.5
5.0	75.5	24.85	77.5	27.25									5.0
6.0	73.3	17.95	75.6	18.70	77.4	19.25							6.0
7.0	71.0	13.60	73.7	14.35	75.7	14.80	77.2	15.20					7.0
8.0	68.8	10.60	71.7	11.20	74.0	11.75	75.7	12.10	76.8	13.75			8.0
9.0	66.4	8.30	69.8	9.00	72.3	9.45	74.2	9.80	75.4	10.05	76.1	10.05	9.0
10.0	64.0	6.60	67.8	7.25	70.6	7.70	72.7	8.05	74.0	8.30	74.8	8.35	10.0
11.0	61.6	5.30	65.8	5.90	68.8	6.35	71.2	6.70	72.6	6.90	73.4	6.90	11.0
12.0	59.1	4.20	63.7	4.80	67.0	5.20	69.6	5.60	71.2	5.80	72.1	5.85	12.0
13.0	56.5	3.30	61.6	3.85	65.2	4.30	68.0	4.70	69.8	4.85	70.7	4.85	13.0
14.0	53.9	2.55	59.4	3.10	63.4	3.55	66.4	3.90	68.3	4.10	69.3	4.10	14.0
15.0	51.1	1.90	57.2	2.45	61.6	2.90	64.8	3.20	66.8	3.45	67.9	3.40	15.0
16.0	48.3	1.35	55.0	1.90	59.7	2.30	63.2	2.65	65.4	2.80	66.5	2.80	16.0
17.0	45.2	0.85	52.6	1.40	57.7	1.80	61.5	2.10	63.9	2.30	65.1	2.35	17.0
18.0	42.0	0.40	50.2	0.95	55.8	1.35	59.9	1.70	62.3	1.90	63.7	1.90	18.0
19.0	38.6	0.05	47.7	0.60	53.7	1.00	58.1	1.30	60.8	1.50	62.2	1.50	19.0
20.0			45.1	0.25	51.7	0.65	56.4	0.95	59.2	1.15	60.7	1.15	20.0
21.0					49.5	0.35	54.6	0.65	57.6	0.85	59.2	0.85	21.0
22.0					47.3	0.05	52.8	0.40	56.0	0.60	57.7	0.60	22.0
23.0							50.9	0.15	54.3	0.35	56.2	0.35	23.0
24.0									52.6	0.10	54.6	0.10	24.0
25.0													25.0
26.0													26.0
27.0													27.0
28.0													28.0
29.0													29.0
30.0													30.0
31.0													31.0
32.0													32.0
33.0													33.0
34.0													34.0
35.0													35.0
36.0													36.0
37.0													37.0
38.0													38.0
39.0													39.0
40.0													40.0
41.0													41.0
42.0													42.0
43.0													43.0
44.0													44.0
45.0													45.0
46.0													46.0
47.0													47.0
48.0													48.0
49.0													49.0
50.0													50.0
	38°STOP		45°STOP		47°STOP		50°STOP		52°STOP		54°STOP		

					
3.00 m x 8.00 m	11.60 m ÷ 53.00 m	T6 On	10.00 t	360°	CODE 06

	t2 = 0% t3 = 0% t4 = 0% t5 = 0% t6 = 0%		t2 = 0% t3 = 0% t4 = 23% t5 = 23% t6 = 23%		t2 = 0% t3 = 0% t4 = 47% t5 = 47% t6 = 47%		t2 = 0% t3 = 0% t4 = 66.6% t5 = 66.6% t6 = 66.6%		t2 = 23% t3 = 23% t4 = 66.6% t5 = 66.6% t6 = 66.6%		t2 = 47% t3 = 47% t4 = 66.6% t5 = 66.6% t6 = 66.6%		
	11.60 m		17.40 m		23.40 m		28.30 m		32.00 m		36.00 m		
													
	Max 78.0°	12.40	Max 78.0°	11.80	Max 78.0°	11.75	Max 78.0°	12.25	Max 78.0°	12.30	Max 78.0°	12.35	
3.0	65.6	12.40	74.2	11.80	78.4	11.75							3.0
3.5	62.8	12.75	72.4	11.95	77.1	11.90							3.5
4.0	59.8	13.20	70.6	12.15	75.8	12.05	78.3	12.25					4.0
4.5	56.8	13.70	68.9	12.35	74.5	12.20	77.3	12.40					4.5
5.0	53.6	14.25	67.0	12.55	73.2	12.35	76.3	12.60	77.9	12.30			5.0
6.0	46.7	15.85	63.3	13.10	70.6	12.70	74.1	12.95	76.1	12.60	77.6	12.35	6.0
7.0	38.7	14.70	59.4	13.70	68.0	13.10	72.0	13.35	74.2	12.90	76.0	12.60	7.0
8.0	28.5	11.55	55.4	13.25	65.3	13.55	69.8	13.75	72.3	13.25	74.3	12.65	8.0
9.0			51.1	10.90	62.5	11.65	67.6	13.05	70.4	11.50	72.6	11.05	9.0
10.0			46.5	9.10	59.6	9.85	65.4	10.25	68.5	9.70	70.9	9.30	10.0
11.0			41.4	7.75	56.7	8.45	63.1	8.85	66.5	8.30	69.2	7.85	11.0
12.0			35.8	6.55	53.6	7.25	60.8	7.60	64.5	7.20	67.5	6.75	12.0
13.0			29.1	5.60	50.4	6.30	58.4	6.65	62.5	6.20	65.7	5.75	13.0
14.0			20.1	4.80	47.0	5.50	55.9	5.85	60.4	5.40	64.0	5.00	14.0
15.0					43.4	4.85	53.4	5.10	58.3	4.70	62.1	4.30	15.0
16.0					39.5	4.25	50.7	4.50	56.1	4.10	60.3	3.75	16.0
17.0					35.3	3.70	48.0	4.00	53.9	3.60	58.4	3.20	17.0
18.0					30.5	3.25	45.1	3.55	51.6	3.10	56.5	2.75	18.0
19.0					24.7	2.85	42.1	3.15	49.3	2.70	54.5	2.35	19.0
20.0					17.1	2.50	38.8	2.80	46.8	2.35	52.5	2.00	20.0
21.0							35.3	2.50	44.2	2.05	50.4	1.70	21.0
22.0							31.5	2.20	41.5	1.75	48.3	1.40	22.0
23.0							27.1	1.95	38.6	1.50	46.1	1.15	23.0
24.0							21.8	1.70	35.5	1.30	43.8	0.90	24.0
25.0							14.6	1.50	32.2	1.05	41.3	0.70	25.0
26.0									28.5	0.85	38.8	0.50	26.0
27.0									24.2	0.65	36.1	0.30	27.0
28.0									18.9	0.50	33.2	0.15	28.0
29.0									11.2	0.35			29.0
30.0													30.0
31.0													31.0
32.0													32.0
33.0													33.0
34.0													34.0
35.0													35.0
36.0													36.0
37.0													37.0
38.0													38.0
39.0													39.0
40.0													40.0
41.0													41.0
42.0													42.0
43.0													43.0
44.0													44.0
45.0													45.0
46.0													46.0
47.0													47.0
48.0													48.0
49.0													49.0
50.0													50.0
	0°	9.40	0°	4.20	0°	2.50	0°	1.40	0°	0.20	33°STOP		

RT100

EN13000



3.00 m x 8.00 m	11.60 m ÷ 53.00 m	T6 On	10.00 t	360°	CODE 06

	t2 = 66.6% t3 = 66.6% t4 = 66.6% t5 = 66.6% t6 = 66.6%		t2 = 85% t3 = 85% t4 = 66.6% t5 = 66.6% t6 = 66.6%		t2 = 94% t3 = 94% t4 = 66.6% t5 = 66.6% t6 = 66.6%		t2 = 94% t3 = 94% t4 = 85% t5 = 85% t6 = 85%		t2 = 94% t3 = 94% t4 = 94% t5 = 94% t6 = 94%		t2 = 100% t3 = 100% t4 = 100% t5 = 100% t6 = 100%		
	39.20 m		42.20 m		43.70 m		48.30 m		50.60 m		53.00 m		
	Max 78.0°	12.05	Max 78.0°	10.60	Max 78.0°	10.80	Max 78.0°	9.25	Max 78.0°	7.75	Max 78.0°	6.50	
3.0													3.0
3.5													3.5
4.0													4.0
4.5													4.5
5.0													5.0
6.0													6.0
7.0	77.1	12.05											7.0
8.0	75.6	12.05	76.7	10.60	77.1	10.80							8.0
9.0	74.1	11.95	75.3	10.60	75.8	10.90	77.2	9.25					9.0
10.0	72.6	9.00	73.8	8.75	74.4	8.65	75.9	9.25	76.6	7.75			10.0
11.0	71.0	7.60	72.4	7.40	73.0	7.25	74.7	7.60	75.4	7.70	76.1	6.50	11.0
12.0	69.4	6.45	71.0	6.25	71.6	6.15	73.5	6.45	74.2	6.45	75.0	6.50	12.0
13.0	67.9	5.50	69.5	5.30	70.2	5.20	72.2	5.50	73.0	5.55	73.9	6.20	13.0
14.0	66.3	4.75	68.1	4.50	68.8	4.45	71.0	4.70	71.8	4.75	72.7	4.80	14.0
15.0	64.6	4.05	66.6	3.85	67.4	3.80	69.7	4.05	70.6	4.10	71.6	4.10	15.0
16.0	63.0	3.45	65.1	3.25	66.0	3.20	68.4	3.40	69.4	3.55	70.4	3.55	16.0
17.0	61.3	2.95	63.5	2.75	64.5	2.70	67.1	2.90	68.2	3.05	69.3	3.05	17.0
18.0	59.6	2.55	62.0	2.30	63.0	2.20	65.8	2.50	67.0	2.60	68.1	2.60	18.0
19.0	57.9	2.10	60.4	1.90	61.5	1.85	64.5	2.10	65.7	2.20	66.9	2.25	19.0
20.0	56.1	1.75	58.8	1.55	60.0	1.50	63.2	1.75	64.5	1.85	65.7	1.90	20.0
21.0	54.3	1.45	57.2	1.25	58.5	1.20	61.8	1.45	63.2	1.55	64.5	1.55	21.0
22.0	52.4	1.15	55.5	1.00	56.9	0.90	60.4	1.15	61.9	1.30	63.3	1.30	22.0
23.0	50.5	0.90	53.9	0.75	55.3	0.65	59.0	0.90	60.6	1.00	62.1	1.05	23.0
24.0	48.6	0.70	52.1	0.50	53.6	0.40	57.6	0.70	59.3	0.80	60.9	0.80	24.0
25.0	46.5	0.45	50.4	0.30	52.0	0.20	56.2	0.45	57.9	0.55	59.6	0.60	25.0
26.0	44.4	0.30	48.5	0.10			54.7	0.25	56.5	0.40	58.3	0.40	26.0
27.0	42.2	0.10					53.2	0.10	55.2	0.20	57.0	0.20	27.0
28.0									53.7	0.05	55.7	0.05	28.0
29.0													29.0
30.0													30.0
31.0													31.0
32.0													32.0
33.0													33.0
34.0													34.0
35.0													35.0
36.0													36.0
37.0													37.0
38.0													38.0
39.0													39.0
40.0													40.0
41.0													41.0
42.0													42.0
43.0													43.0
44.0													44.0
45.0													45.0
46.0													46.0
47.0													47.0
48.0													48.0
49.0													49.0
50.0													50.0
	42°STOP		48°STOP		52°STOP		53°STOP		53°STOP		55°STOP		

29.5R25	0 km/h	T6 Off	10.00 t	360°	CODE 07
---------	--------	--------	---------	------	---------



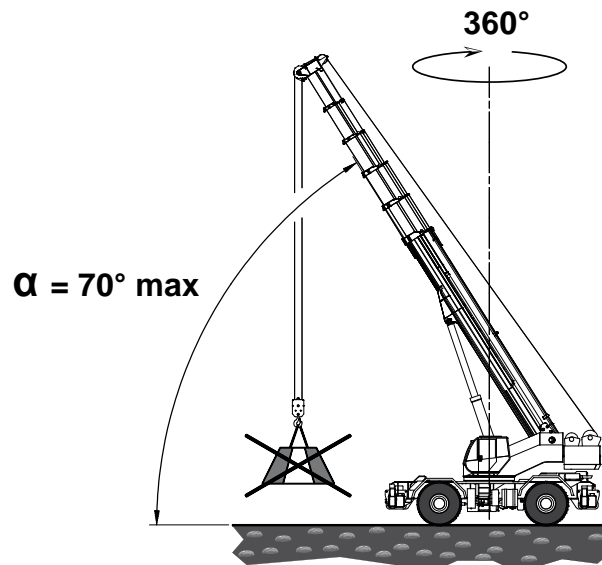

	t2 = 0% t3 = 0% t4 = 0% t5 = 0% t6 = 0%		t2 = 16.7% t3 = 16.7% t4 = 0% t5 = 0% t6 = 0%		t2 = 33.3% t3 = 33.3% t4 = 0% t5 = 0% t6 = 0%		t2 = 50% t3 = 50% t4 = 0% t5 = 0% t6 = 0%		t2 = 66.6% t3 = 66.6% t4 = 0% t5 = 0% t6 = 0%		t2 = 83.3% t3 = 83.3% t4 = 0% t5 = 0% t6 = 0%		t2 = 94% t3 = 94% t4 = 0% t5 = 0% t6 = 0%		
	11.60 m		14.30 m		17.00 m		19.80 m		22.50 m		25.20 m		26.90 m		
	Max 70.0°	32.65	Max 70.0°	28.20	Max 70.0°	24.60	Max 70.0°	19.40	Max 70.0°	14.65	Max 70.0°	11.00	Max 70.0°	8.40	
3.0	65.6	32.65													3.0
3.5	62.8	28.55	68.4	28.20											3.5
4.0	59.8	25.20	66.2	24.85	70.0	24.60									4.0
4.5	56.8	22.45	63.9	22.10	68.4	21.90									4.5
5.0	53.6	20.15	61.6	19.80	66.5	19.60	70.0	19.40							5.0
6.0	46.7	15.65	56.7	15.25	62.7	15.15	66.8	14.80	69.8	14.65					6.0
7.0	38.7	12.00	51.6	11.70	58.7	11.40	63.6	11.20	67.0	11.10	69.7	11.00			7.0
8.0	28.5	9.45	45.9	9.10	54.6	8.85	60.2	8.70	64.2	8.55	67.2	8.45	68.8	8.40	8.0
9.0			39.6	7.25	50.1	7.00	56.7	6.80	61.2	6.70	64.6	6.60	66.4	6.55	9.0
10.0			32.0	5.70	45.3	5.50	53.0	5.35	58.2	5.25	62.0	5.15	64.0	5.10	10.0
11.0			21.9	4.50	40.1	4.35	49.1	4.20	55.1	4.10	59.4	4.00	61.6	3.95	11.0
12.0					34.0	3.40	45.0	3.25	51.8	3.15	56.6	3.05	59.1	3.00	12.0
13.0					26.7	2.60	40.5	2.50	48.3	2.35	53.8	2.30	56.5	2.25	13.0
14.0					16.0	1.90	35.5	1.80	44.7	1.70	50.8	1.60	53.9	1.60	14.0
15.0							29.6	1.25	40.7	1.15	47.7	1.05	51.1	1.00	15.0
16.0							22.3	0.70	36.4	0.65	44.5	0.55	48.3	0.55	16.0
17.0									31.6	0.20	41.0	0.15	45.2	0.10	17.0
18.0															18.0
19.0															19.0
20.0															20.0
21.0															21.0
22.0															22.0
23.0															23.0
24.0															24.0
25.0															25.0
26.0															26.0
27.0															27.0
28.0															28.0
29.0															29.0
30.0															30.0
	0°	7.50	0°	3.70	0°	1.60	0°	0.20	31° STOP		41° STOP		45° STOP		
min															min



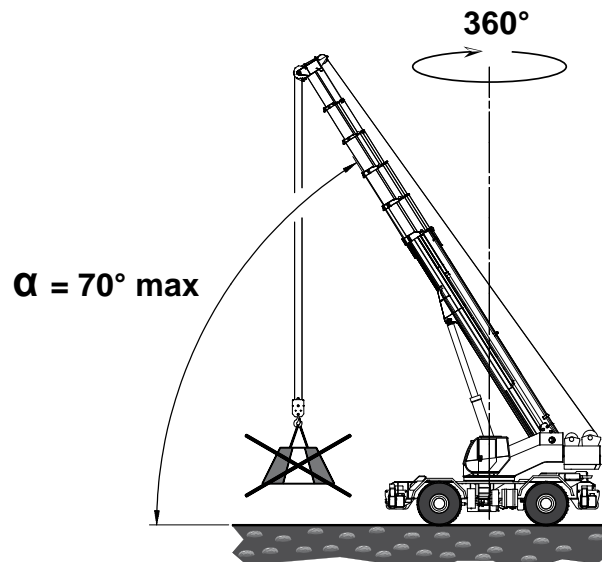



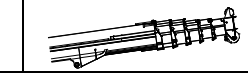
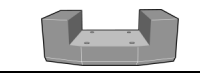





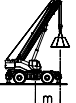









29.5R25	0 km/h	T6 On	10.00 t	360°	CODE 08
---------	--------	-------	---------	------	---------

	11.60 m		17.40 m		23.40 m		28.30 m		
	Max 70.0°	12.40	Max 70.0°	12.35	Max 70.0°	13.10	Max 70.0°	12.15	
3.0	65.6	12.40							3.0
3.5	62.8	12.75							3.5
4.0	59.8	13.20							4.0
4.5	56.8	13.70	68.9	12.35					4.5
5.0	53.6	14.25	67.0	12.55					5.0
6.0	46.7	15.85	63.3	13.10					6.0
7.0	38.7	12.00	59.4	13.65	68.0	13.10			7.0
8.0	28.5	9.40	55.4	11.00	65.3	11.75	69.8	12.15	8.0
9.0			51.1	9.05	62.5	9.85	67.6	10.15	9.0
10.0			46.5	7.50	59.6	8.25	65.4	8.65	10.0
11.0			41.4	6.30	56.7	7.00	63.1	7.35	11.0
12.0			35.8	5.30	53.6	6.05	60.8	6.35	12.0
13.0			29.1	4.50	50.4	5.20	58.4	5.55	13.0
14.0			20.1	3.80	47.0	4.50	55.9	4.85	14.0
15.0					43.4	3.95	53.4	4.15	15.0
16.0					39.5	3.40	50.7	3.65	16.0
17.0					35.3	2.95	48.0	3.20	17.0
18.0					30.5	2.55	45.1	2.80	18.0
19.0					24.7	2.15	42.1	2.50	19.0
20.0					17.1	1.85	38.8	2.15	20.0
21.0							35.3	1.90	21.0
22.0							31.5	1.65	22.0
23.0							27.1	1.40	23.0
24.0							21.8	1.20	24.0
25.0							14.6	1.00	25.0
26.0									26.0
27.0									27.0
28.0									28.0
29.0									29.0
30.0									30.0
	0°	7.50	0°	3.30	0°	1.60	0°	0.80	
min									min







 29.5R25	 2 km/h	 T6 Off	 10.00 t	 0°	 CODE 09
---	---	---	---	---	--







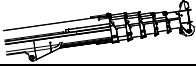
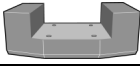





	t2 = 0% t3 = 0% t4 = 0% t5 = 0% t6 = 0%		t2 = 16.7% t3 = 16.7% t4 = 0% t5 = 0% t6 = 0%		t2 = 33.3% t3 = 33.3% t4 = 0% t5 = 0% t6 = 0%		t2 = 50% t3 = 50% t4 = 0% t5 = 0% t6 = 0%		t2 = 66.6% t3 = 66.6% t4 = 0% t5 = 0% t6 = 0%		t2 = 83.3% t3 = 83.3% t4 = 0% t5 = 0% t6 = 0%		t2 = 94% t3 = 94% t4 = 0% t5 = 0% t6 = 0%		
	11.60 m		14.30 m		17.00 m		19.80 m		22.50 m		25.20 m		26.90 m		
															
	Max 78.0°	32.90	Max 78.0°	32.65	Max 78.0°	32.50	Max 78.0°	32.35	Max 78.0°	32.30	Max 78.0°	28.85	Max 78.0°	26.00	
3.0	65.6	32.90	70.6	32.65	73.8	32.50	76.2	32.35	77.9	32.30					3.0
3.5	62.8	29.60	68.4	29.35	72.1	29.15	74.6	29.00	76.6	28.95	78.0	28.85			3.5
4.0	59.8	26.80	66.2	26.50	70.2	26.35	73.1	26.20	75.2	26.10	76.9	26.05	77.7	26.00	4.0
4.5	56.8	24.40	63.9	24.15	68.4	23.95	71.6	23.80	73.9	23.70	75.7	23.65	76.6	23.55	4.5
5.0	53.6	22.35	61.6	22.05	66.5	21.85	70.0	21.70	72.5	21.60	74.5	21.55	75.5	21.50	5.0
6.0	46.7	18.90	56.7	18.65	62.7	18.45	66.8	18.30	69.8	18.20	72.1	18.10	73.3	18.05	6.0
7.0	38.7	16.20	51.6	15.90	58.7	15.75	63.6	15.60	67.0	15.50	69.7	15.40	71.0	15.35	7.0
8.0	28.5	13.95	45.9	13.70	54.6	13.55	60.2	13.40	64.2	13.25	67.2	13.20	68.8	13.15	8.0
9.0			39.6	11.90	50.1	11.70	56.7	11.55	61.2	11.45	64.6	11.40	66.4	11.35	9.0
10.0			32.0	10.35	45.3	10.20	53.0	10.05	58.2	9.95	62.0	9.85	64.0	9.80	10.0
11.0			21.9	9.00	40.1	8.85	49.1	8.75	55.1	8.55	59.4	8.45	61.6	8.45	11.0
12.0					34.0	7.35	45.0	7.20	51.8	7.10	56.6	7.00	59.1	7.00	12.0
13.0					26.7	6.15	40.5	6.00	48.3	5.90	53.8	5.80	56.5	5.75	13.0
14.0					16.0	5.10	35.5	5.00	44.7	4.90	50.8	4.80	53.9	4.75	14.0
15.0							29.6	4.15	40.7	4.05	47.7	4.00	51.1	3.90	15.0
16.0							22.3	3.40	36.4	3.30	44.5	3.25	48.3	3.20	16.0
17.0									31.6	2.70	41.0	2.60	45.2	2.55	17.0
18.0									25.8	2.10	37.2	2.05	42.0	2.00	18.0
19.0									18.2	1.60	33.0	1.55	38.6	1.50	19.0
20.0											28.3	1.15	34.9	1.10	20.0
21.0											22.5	0.75	30.7	0.70	21.0
22.0											14.5	0.40	26.0	0.35	22.0
23.0													20.0	0.05	23.0
24.0															24.0
25.0															25.0
26.0															26.0
27.0															27.0
28.0															28.0
29.0															29.0
30.0															30.0
	0°	13.90	0°	7.90	0°	5.00	0°	2.60	0°	1.20	0°	0.20	20° STOP		





RT100







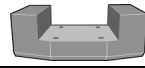





EN13000

**TEREX®**

 29.5R25	 2 km/h	 T6 On	 10.00 t	 0°	 CODE 10
---	---	--	--	---	--

	t2 = 0% t3 = 0% t4 = 0% t5 = 0% t6 = 0%		t2 = 0% t3 = 0% t4 = 23% t5 = 23% t6 = 23%		t2 = 0% t3 = 0% t4 = 47% t5 = 47% t6 = 47%		t2 = 0% t3 = 0% t4 = 66.6% t5 = 66.6% t6 = 66.6%		
	11.60 m		17.40 m		23.40 m		28.30 m		
	 Max 78.0°	 12.40	 Max 78.0°	 11.80	 Max 78.0°	 11.75	 Max 78.0°	 12.25	
3.0	65.6	12.40	74.2	11.80	78.4	11.75			3.0
3.5	62.8	12.75	72.4	11.95	77.1	11.90			3.5
4.0	59.8	13.20	70.6	12.15	75.8	12.05	78.3	12.25	4.0
4.5	56.8	13.65	68.9	12.35	74.5	12.20	77.3	12.40	4.5
5.0	53.6	14.25	67.0	12.55	73.2	12.35	76.3	12.60	5.0
6.0	46.7	15.85	63.3	13.10	70.6	12.70	74.1	12.95	6.0
7.0	38.7	16.20	59.4	13.70	68.0	13.10	72.0	13.35	7.0
8.0	28.5	13.95	55.4	14.50	65.3	13.55	69.8	13.75	8.0
9.0			51.1	13.50	62.5	14.05	67.6	13.05	9.0
10.0			46.5	12.00	59.6	12.65	65.4	11.80	10.0
11.0			41.4	10.70	56.7	11.35	63.1	10.90	11.0
12.0			35.8	9.40	53.6	10.15	60.8	10.00	12.0
13.0			29.1	8.15	50.4	8.90	58.4	9.20	13.0
14.0			20.1	7.10	47.0	7.85	55.9	8.50	14.0
15.0					43.4	6.95	53.4	7.95	15.0
16.0					39.5	6.25	50.7	6.45	16.0
17.0					35.3	5.55	48.0	5.85	17.0
18.0					30.5	4.95	45.1	5.25	18.0
19.0					24.7	4.45	42.1	4.75	19.0
20.0					17.1	4.00	38.8	4.30	20.0
21.0							35.3	3.90	21.0
22.0							31.5	3.50	22.0
23.0							27.1	3.20	23.0
24.0							21.8	2.90	24.0
25.0							14.6	2.60	25.0
26.0									26.0
27.0									27.0
28.0									28.0
29.0									29.0
30.0									30.0
 min	0°	13.90	0°	7.00	0°	3.90	0°	2.50	 min

					
8.00 m x 8.00 m	11.60 m ÷ 53.00 m	T6 On	10.00 t	360°	8.00 m

	t2 = 94% t3 = 94% t4 = 85% t5 = 85% t6 = 85%		t2 = 94% t3 = 94% t4 = 85% t5 = 85% t6 = 85%		t2 = 94% t3 = 94% t4 = 85% t5 = 85% t6 = 85%		t2 = 100% t3 = 100% t4 = 100% t5 = 100% t6 = 100%		t2 = 100% t3 = 100% t4 = 100% t5 = 100% t6 = 100%		t2 = 100% t3 = 100% t4 = 100% t5 = 100% t6 = 100%		
	48.70m + 8.00m 0°		48.70m + 8.00m 20°		48.70m + 8.00m 40°		53.00m + 8.00m 0°		53.00m + 8.00m 20°		53.00m + 8.00m 40°		
		CODE 09		CODE 10		CODE 12		CODE 09		CODE 10		CODE 12	
	Max 78.0°	4.10	Max 78.0°	3.75	Max 78.0°	2.65	Max 78.0°	3.35	Max 78.0°	2.90	Max 78.0°	2.25	
9.0													9.0
10.0	77.1	4.10											10.0
11.0	76.1	4.15					77.2	3.35					11.0
12.0	75.1	4.20	77.8	3.75			76.2	3.35					12.0
13.0	74.0	4.25	76.8	3.65			75.3	3.35	77.8	2.90			13.0
14.0	73.0	4.30	75.7	3.55	78.0	2.65	74.3	3.30	76.9	2.75			14.0
15.0	71.9	4.35	74.7	3.45	77.0	2.60	73.3	3.25	75.9	2.65	78.0	2.25	15.0
16.0	70.8	4.40	73.6	3.35	75.9	2.60	72.4	3.10	74.9	2.50	77.1	2.15	16.0
17.0	69.8	4.45	72.5	3.30	74.8	2.55	71.4	2.90	73.9	2.40	76.1	2.10	17.0
18.0	68.7	4.45	71.4	3.25	73.7	2.55	70.4	2.75	72.9	2.25	75.0	2.00	18.0
19.0	67.6	4.45	70.3	3.15	72.6	2.50	69.4	2.60	71.9	2.15	74.0	1.90	19.0
20.0	66.5	4.25	69.2	3.10	71.4	2.45	68.4	2.45	70.9	2.05	73.0	1.85	20.0
21.0	65.4	4.05	68.1	3.00	70.3	2.45	67.4	2.35	69.9	2.00	72.0	1.80	21.0
22.0	64.2	3.80	67.0	2.95	69.2	2.40	66.4	2.25	68.9	1.90	70.9	1.70	22.0
23.0	63.1	3.60	65.9	2.90	68.0	2.40	65.3	2.10	67.9	1.80	69.9	1.65	23.0
24.0	62.0	3.40	64.7	2.90	66.8	2.35	64.3	2.00	66.8	1.75	68.8	1.60	24.0
25.0	60.8	3.20	63.5	2.85	65.6	2.35	63.3	1.95	65.8	1.70	67.8	1.55	25.0
26.0	59.7	3.05	62.4	2.80	64.4	2.30	62.2	1.85	64.7	1.60	66.7	1.50	26.0
27.0	58.5	2.85	61.2	2.70	63.2	2.30	61.2	1.75	63.7	1.55	65.6	1.45	27.0
28.0	57.3	2.70	60.0	2.70	62.0	2.30	60.1	1.70	62.6	1.50	64.5	1.40	28.0
29.0	56.1	2.55	58.8	2.65	60.7	2.30	59.0	1.60	61.5	1.45	63.4	1.35	29.0
30.0	54.8	2.40	57.5	2.50	59.5	2.25	57.9	1.55	60.4	1.40	62.3	1.30	30.0
31.0	53.6	2.25	56.3	2.40	58.2	2.25	56.8	1.45	59.3	1.35	61.1	1.25	31.0
32.0	52.3	2.15	55.0	2.25	56.9	2.20	55.7	1.40	58.2	1.30	60.0	1.20	32.0
33.0	51.0	2.00	53.7	2.10	55.5	2.15	54.5	1.35	57.0	1.25	58.8	1.20	33.0
34.0	49.7	1.90	52.4	2.00	54.2	2.05	53.4	1.30	55.9	1.20	57.6	1.15	34.0
35.0	48.4	1.75	51.0	1.85	52.8	1.95	52.2	1.25	54.7	1.15	56.4	1.10	35.0
36.0	47.0	1.65	49.7	1.75	51.4	1.85	51.0	1.20	53.5	1.10	55.2	1.05	36.0
37.0	45.6	1.50	48.2	1.65	49.9	1.75	49.8	1.15	52.3	1.05	53.9	1.05	37.0
38.0	44.2	1.40	46.8	1.55	48.4	1.60	48.6	1.05	51.0	1.05	52.6	1.00	38.0
39.0	42.7	1.30	45.3	1.45	46.9	1.50	47.3	0.95	49.8	1.00	51.3	0.95	39.0
40.0	41.2	1.20	43.8	1.35	45.3	1.40	46.0	0.85	48.5	0.95	50.0	0.95	40.0
41.0	39.6	1.10	42.2	1.20	43.6	1.30	44.7	0.70	47.1	0.90	48.6	0.90	41.0
42.0	38.0	1.00	40.6	1.10	41.9	1.20	43.4	0.65	45.8	0.80	47.2	0.85	42.0
43.0	36.3	0.90	38.9	1.00	40.1	1.05	42.0	0.55	44.4	0.65	45.8	0.80	43.0
44.0	34.6	0.75	37.1	0.90	38.3	0.95	40.6	0.45	43.0	0.60	44.3	0.65	44.0
45.0	32.7	0.70	35.3	0.75	36.3	0.80	39.1	0.35	41.5	0.50	42.7	0.60	45.0
46.0	30.8	0.55	33.3	0.70	34.2	0.75	37.6	0.30	40.0	0.40	41.2	0.50	46.0
47.0	28.8	0.50	31.3	0.60	32.0	0.65	36.0	0.25	38.4	0.35	39.5	0.40	47.0
48.0	26.6	0.35	29.0	0.45	29.5	0.50			36.8	0.25	37.8	0.30	48.0
49.0	24.2	0.25	26.6	0.35	26.9	0.35					36.0	0.25	49.0
50.0			24.0	0.25	23.8	0.25							50.0
51.0													51.0
52.0													52.0
53.0													53.0
54.0													54.0
55.0													55.0
min	23° STOP		23° STOP		22° STOP		35° STOP		35° STOP		35° STOP		min

RT100

EN13000

**TEREX®**

8.00 m x 8.00 m

11.60 m ÷ 53.00 m

T6 On

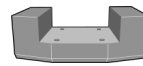











10.00 t



360°



15.00 m

	 t2 = 100% t3 = 100% t4 = 100% t5 = 100% t6 = 100%		 t2 = 100% t3 = 100% t4 = 100% t5 = 100% t6 = 100%		 t2 = 100% t3 = 100% t4 = 100% t5 = 100% t6 = 100%		
	53.00m + 15.00m 0°		53.00m + 15.00m 20°		53.00m + 15.00m 40°		
	 CODE 13		 CODE 14		 CODE 16		
	Max 78.0°	 1.95	Max 78.0°	 1.30	Max 78.0°	 0.95	
9.0							9.0
10.0							10.0
11.0							11.0
12.0	77.7	1.95					12.0
13.0	76.8	2.00					13.0
14.0	76.0	2.00					14.0
15.0	75.1	2.00					15.0
16.0	74.2	2.00					16.0
17.0	73.3	1.95	77.6	1.30			17.0
18.0	72.5	1.90	76.7	1.25			18.0
19.0	71.6	1.85	75.8	1.25			19.0
20.0	70.7	1.80	74.9	1.20			20.0
21.0	69.8	1.75	74.0	1.20	77.6	0.95	21.0
22.0	68.9	1.65	73.1	1.20	76.7	0.95	22.0
23.0	68.0	1.60	72.2	1.15	75.7	0.90	23.0
24.0	67.1	1.50	71.3	1.15	74.8	0.90	24.0
25.0	66.2	1.45	70.4	1.10	73.8	0.90	25.0
26.0	65.3	1.40	69.5	1.10	72.9	0.90	26.0
27.0	64.3	1.30	68.5	1.10	71.9	0.90	27.0
28.0	63.4	1.25	67.6	1.05	70.9	0.90	28.0
29.0	62.5	1.20	66.6	1.05	70.0	0.85	29.0
30.0	61.5	1.15	65.7	1.00	69.0	0.85	30.0
31.0	60.6	1.10	64.7	0.95	68.0	0.85	31.0
32.0	59.6	1.05	63.7	0.90	66.9	0.85	32.0
33.0	58.6	1.00	62.7	0.90	65.9	0.80	33.0
34.0	57.6	0.95	61.7	0.85	64.9	0.80	34.0
35.0	56.6	0.90	60.7	0.80	63.8	0.75	35.0
36.0	55.6	0.90	59.7	0.80	62.8	0.75	36.0
37.0	54.6	0.85	58.7	0.75	61.7	0.70	37.0
38.0	53.6	0.80	57.6	0.75	60.6	0.70	38.0
39.0	52.5	0.80	56.6	0.70	59.5	0.70	39.0
40.0	51.4	0.75	55.5	0.70	58.4	0.65	40.0
41.0	50.4	0.70	54.4	0.65	57.2	0.65	41.0
42.0	49.3	0.70	53.3	0.65	56.0	0.60	42.0
43.0	48.1	0.65	52.2	0.60	54.9	0.60	43.0
44.0	47.0	0.65	51.0	0.60	53.6	0.55	44.0
45.0	45.9	0.60	49.8	0.55	52.4	0.55	45.0
46.0	44.7	0.55	48.6	0.55	51.1	0.55	46.0
47.0	43.5	0.45	47.4	0.55	49.8	0.50	47.0
48.0	42.2	0.40	46.2	0.50	48.5	0.50	48.0
49.0	41.0	0.30	44.9	0.50	47.1	0.50	49.0
50.0	39.7	0.25	43.6	0.45	45.7	0.45	50.0
51.0			42.2	0.35	44.3	0.45	51.0
52.0			40.8	0.30	42.7	0.40	52.0
53.0			39.4	0.25	41.2	0.35	53.0
54.0					39.5	0.25	54.0
55.0							55.0
min	38° STOP		37° STOP		37° STOP		min

